

A
B
C
D
E
F
G
H

Modul 1
CPU 1215C DC/DC/DC
6ES7 215-1AG40-0XB0

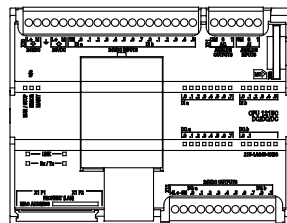

-A1

- ⊗ 2-D3
- ⊗ 3-C4
- ⊗ 3-C7

Modul 2
SM 1231 AI
6ES7 231-4HF32-0XB0

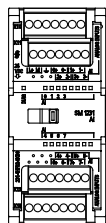

-A3

- ⊗ 2-E6
- ⊗ 3-C9

Modul 3
SM 1231 RTD
6ES7 231-5PD32-0XB0

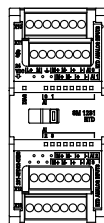

-A4

- ⊗ 2-G6
- ⊗ 3-C12

Auteur :
Date :

PLC Physical

Fichier :
Folio : 1/3

A
B
C
D
E
F
G
H

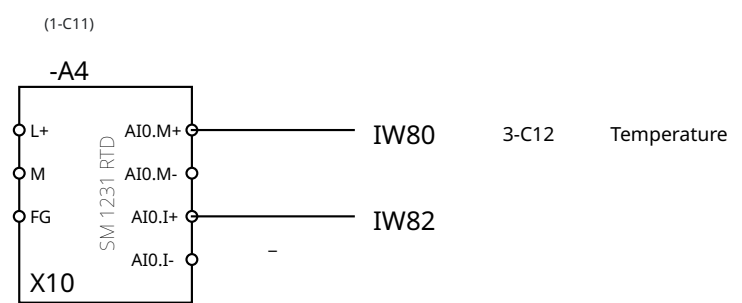
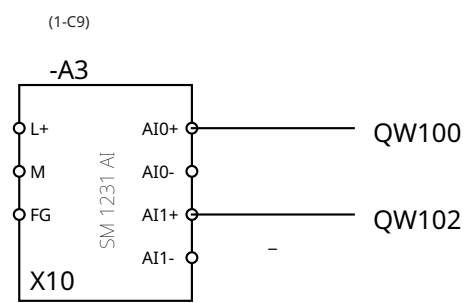
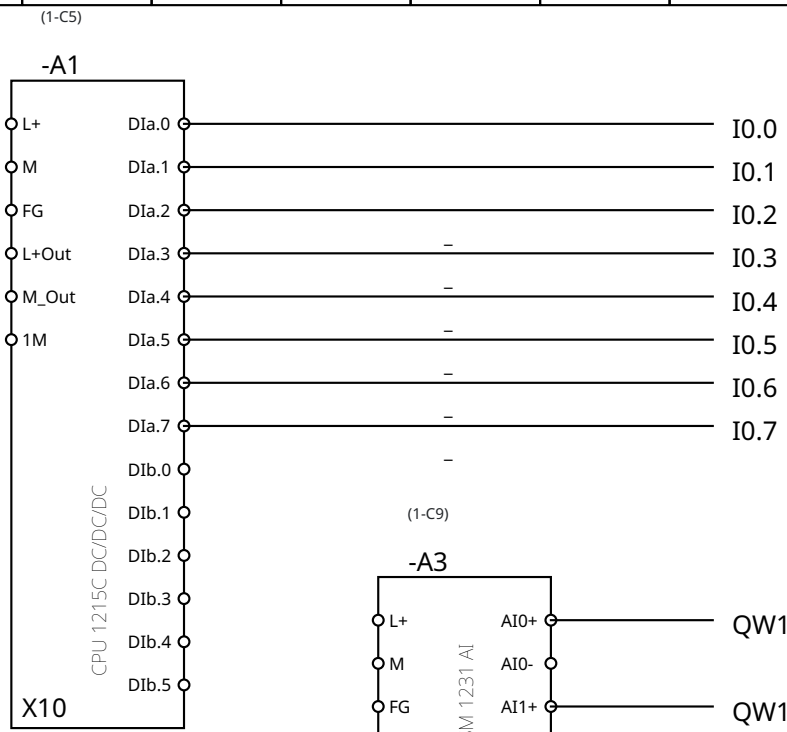

Auteur :
Date :

PLC Module Connections

Fichier :
Folio : 2/3

Switch acknowledge

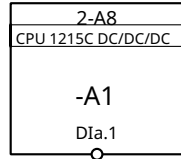

Sensor door open

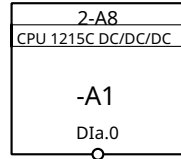

Weight



Temperature

