

A  
B  
C  
D  
E  
F  
G  
H  
I  
J

DEPUIS TRANSFO DEFIBRAGE 1  
DEPART RAFFINEURS 1.2.3

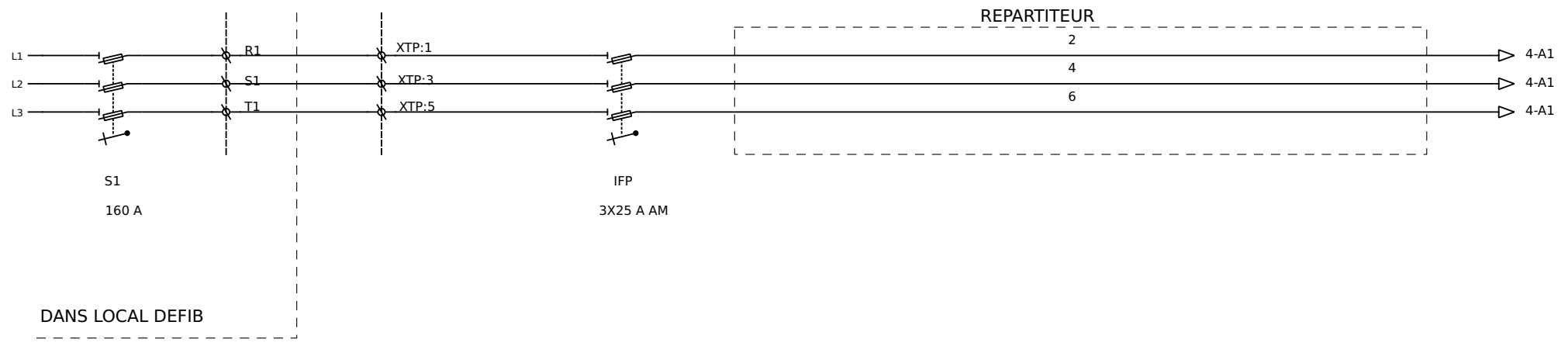

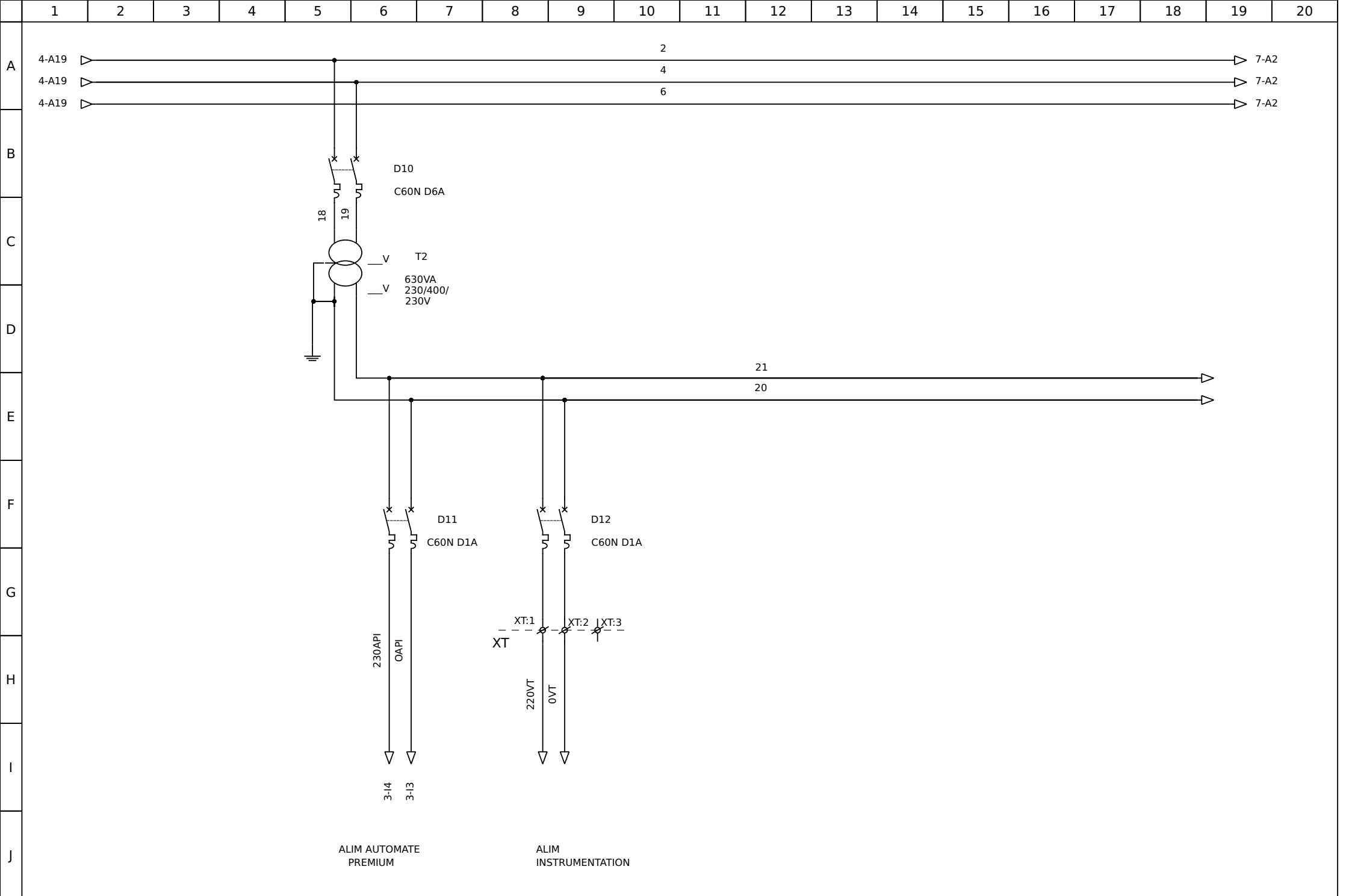

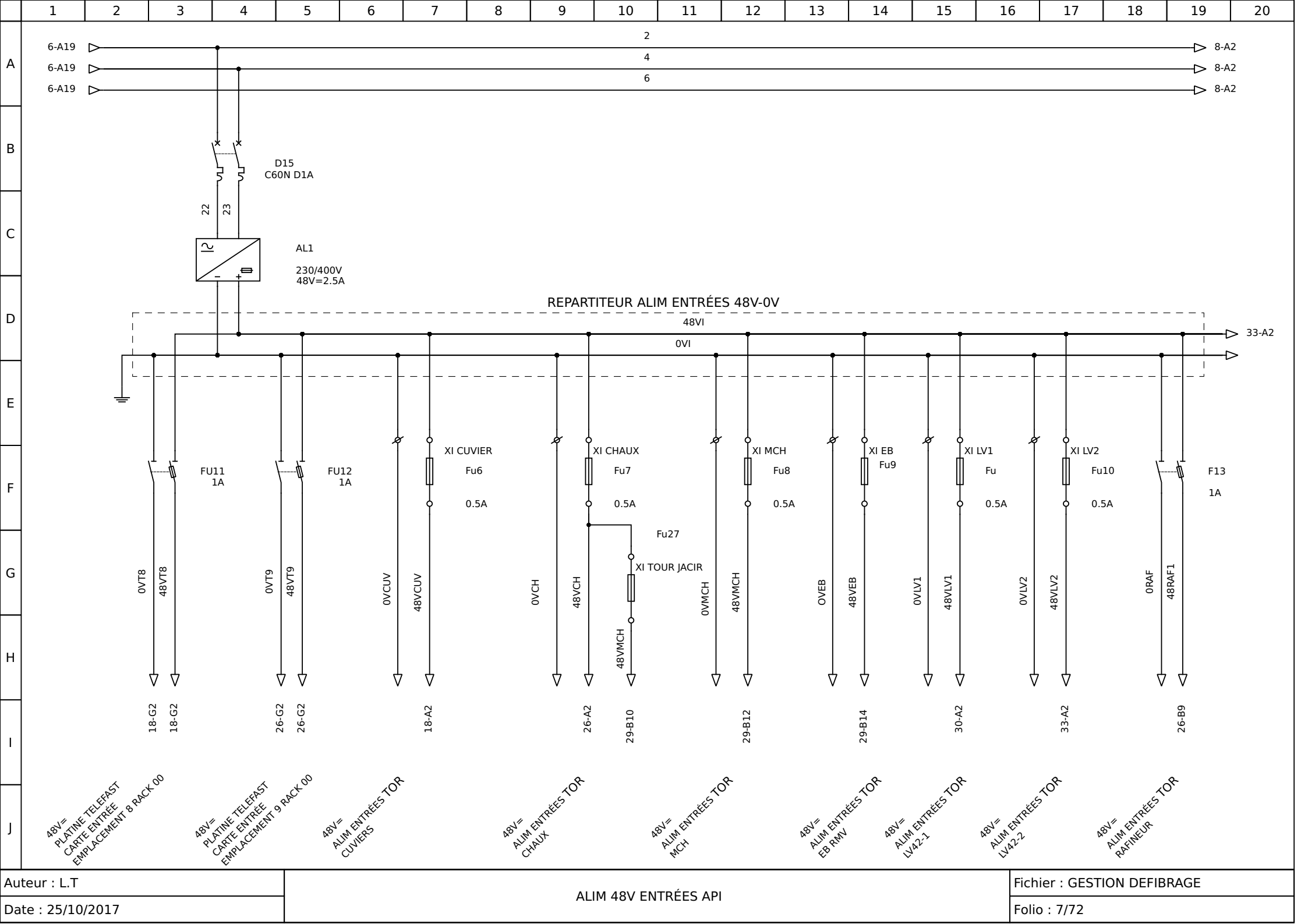

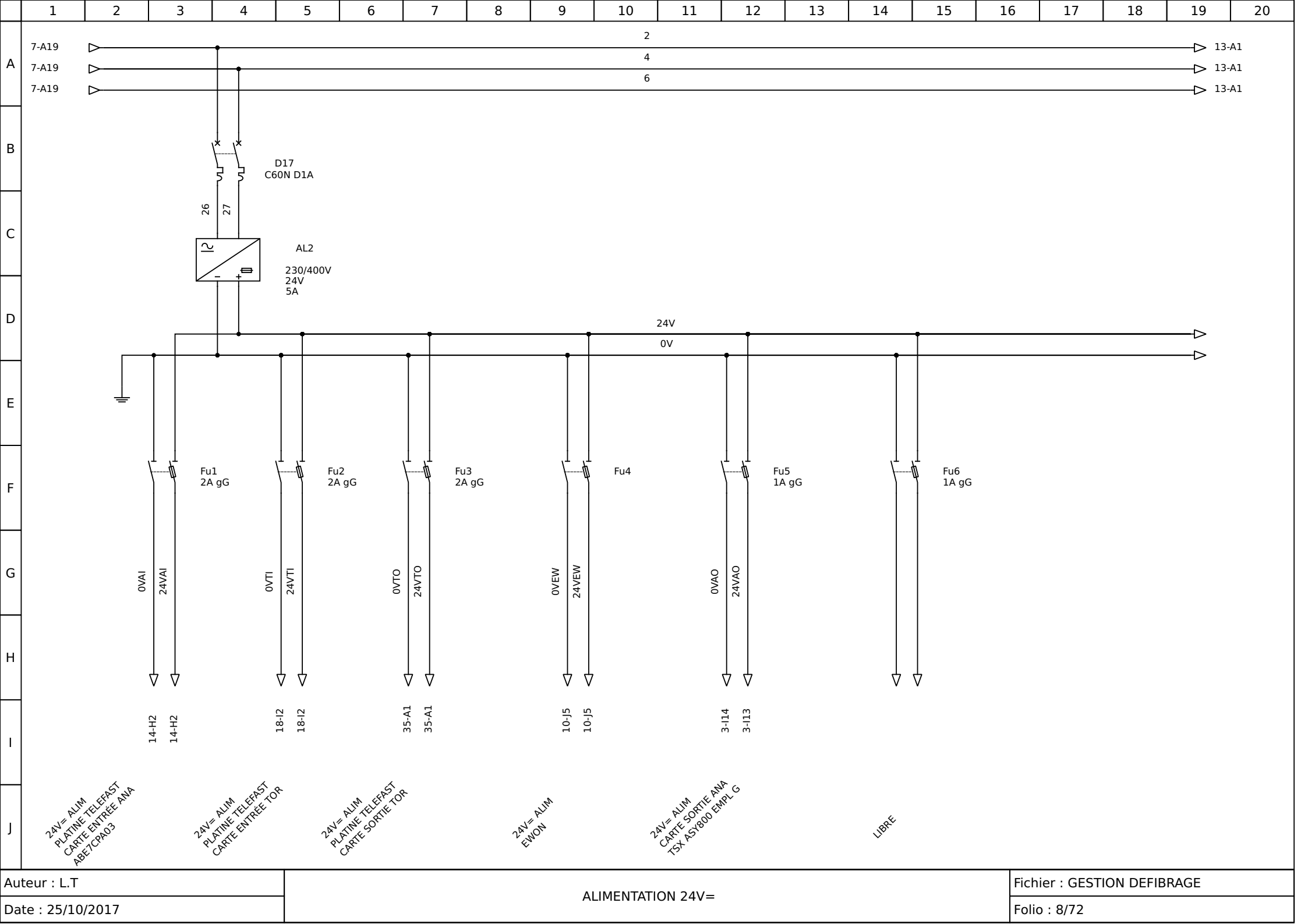

24V= ALIM  
 PLATINE TELEFAST  
 CARTE ENTREE ANA  
 ABE7CPA03

24V= ALIM  
 PLATINE TELEFAST  
 CARTE ENTREE TOR

24V= ALIM  
 PLATINE TELEFAST  
 CARTE SORTIE TOR

24V= ALIM  
 EWON

24V= ALIM  
 CARTE SORTIE ANA  
 TSX AS1800 Empl G

LIBRE



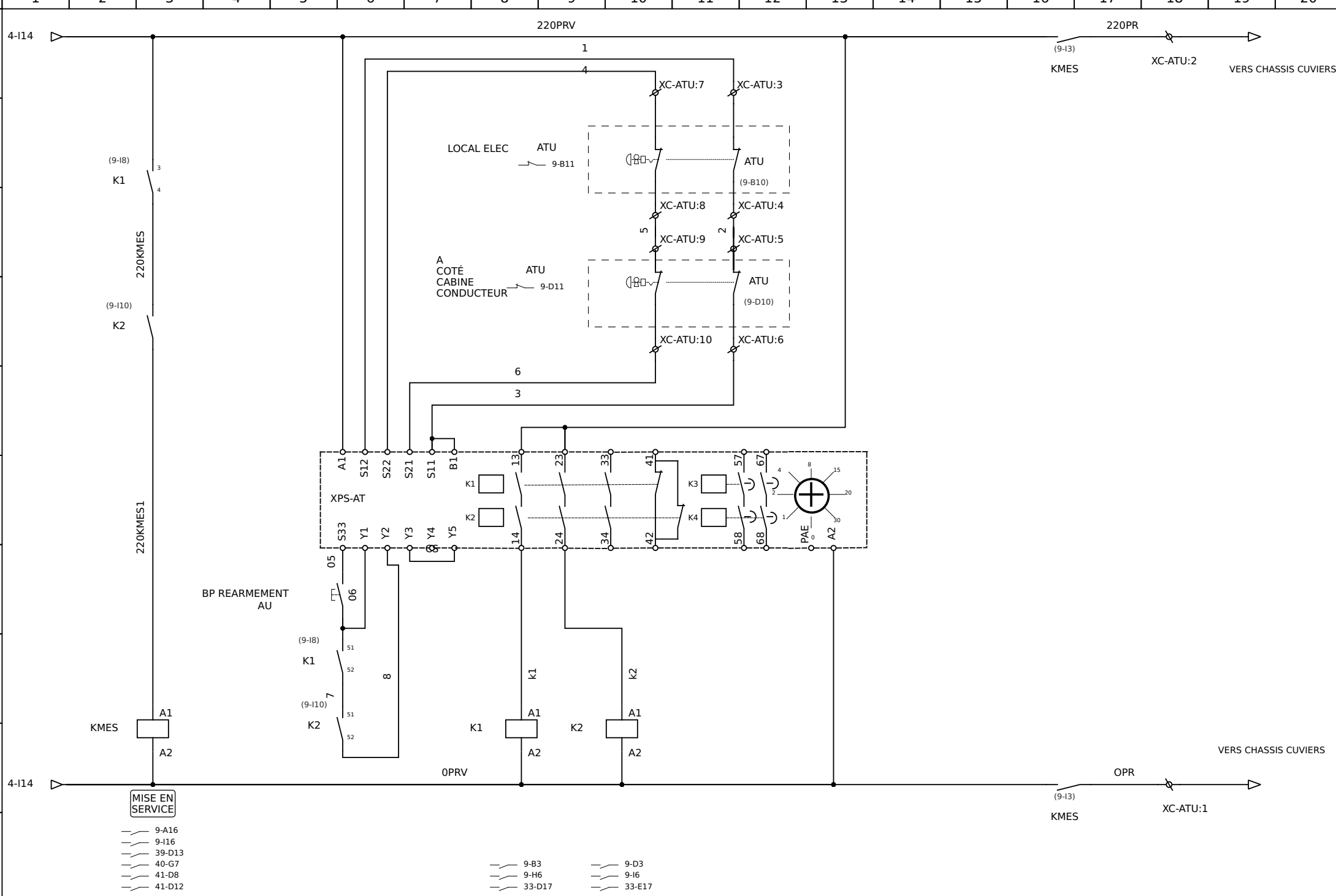

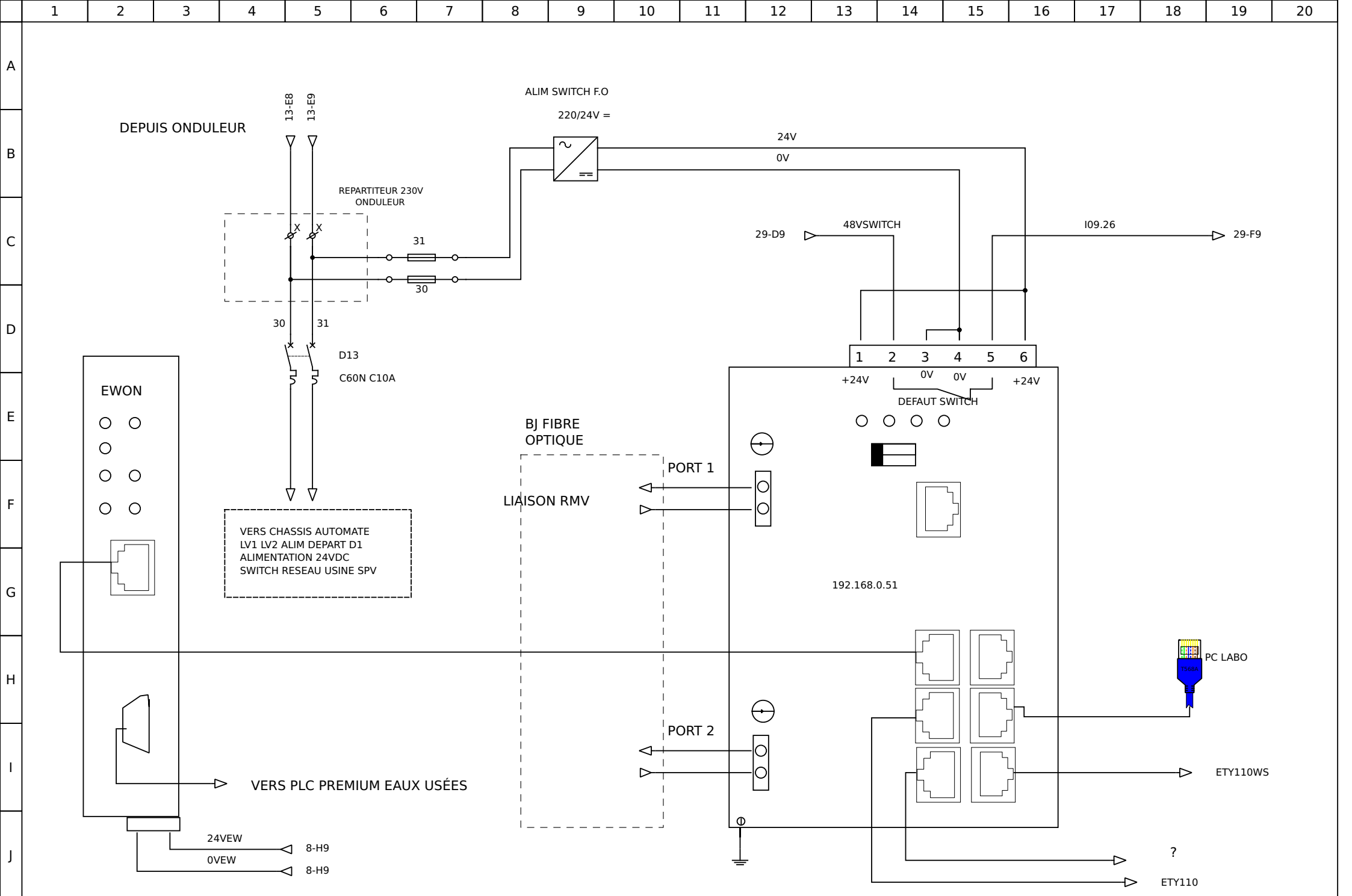

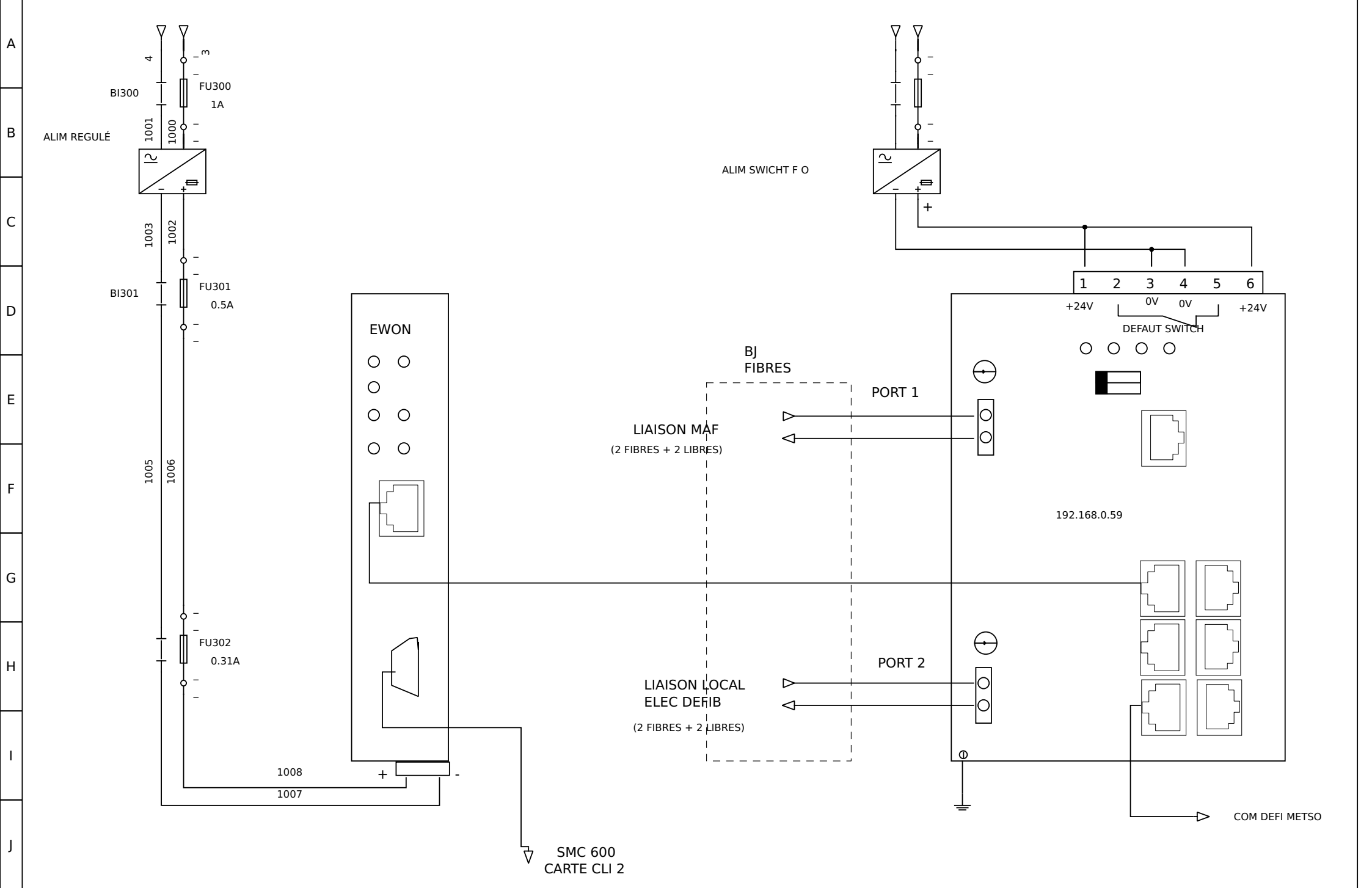

### SCHÉMA CABLAGE BOITE SONDES DE NIVEAUX 1 ER ETAGE

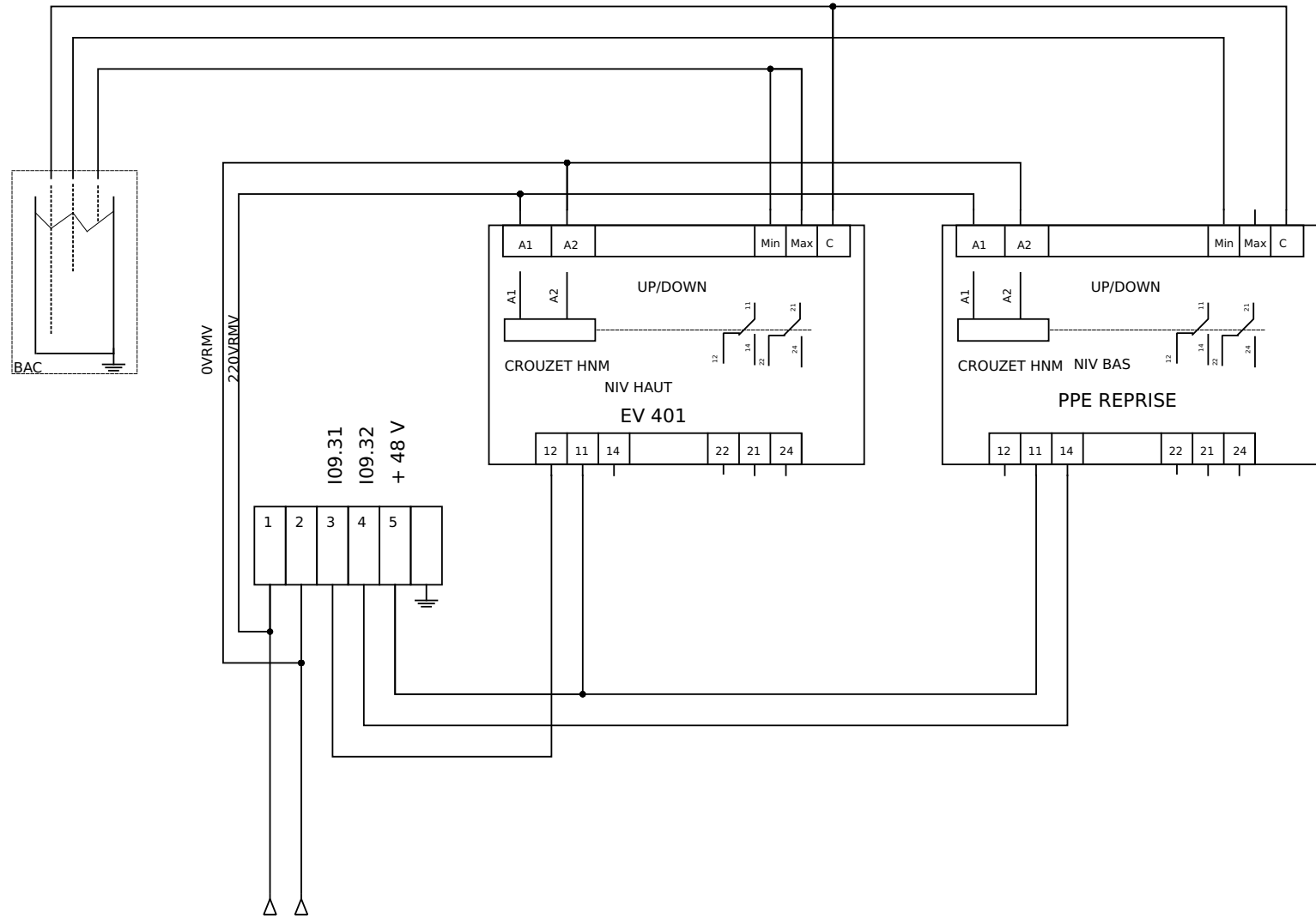

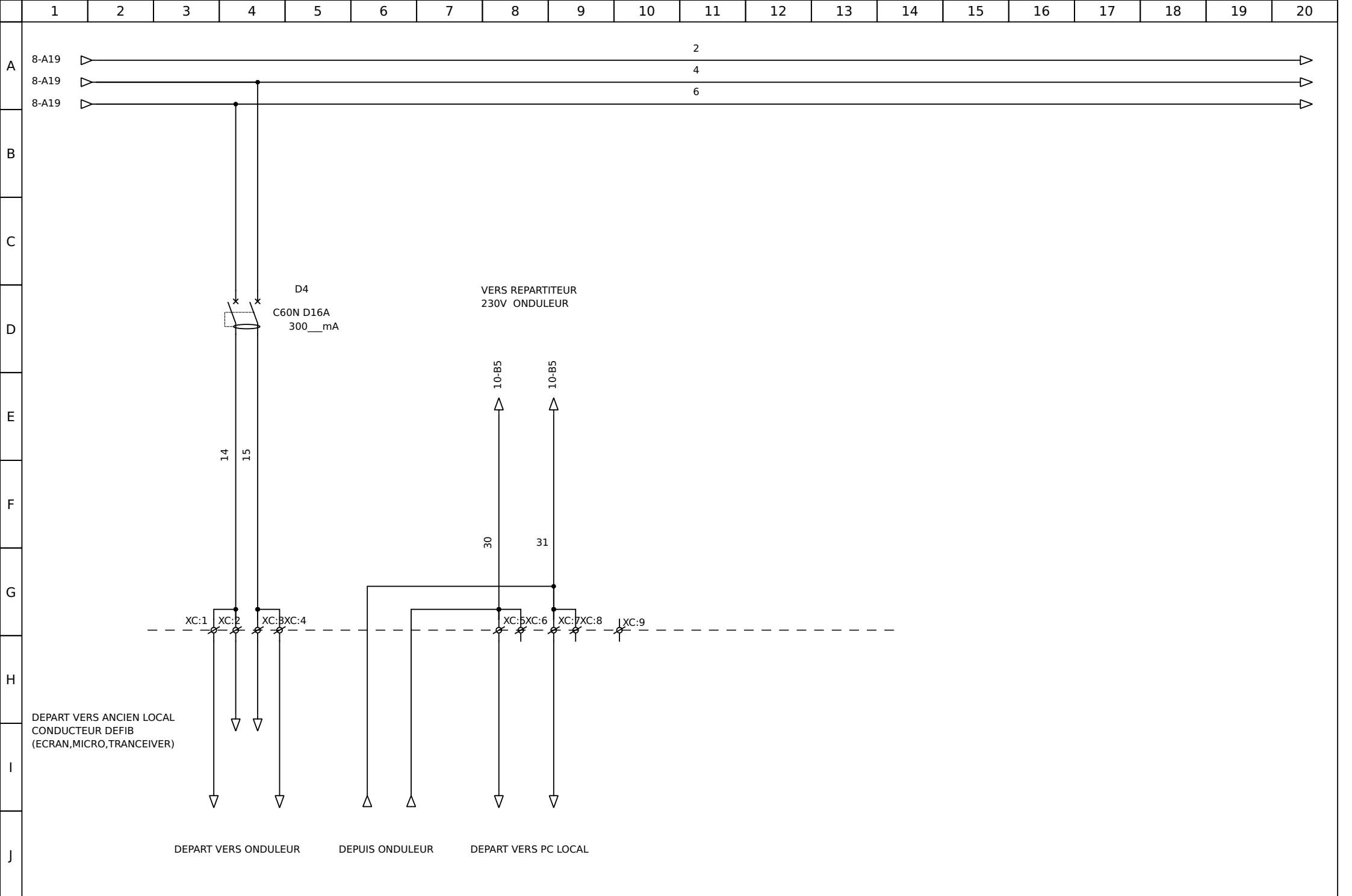

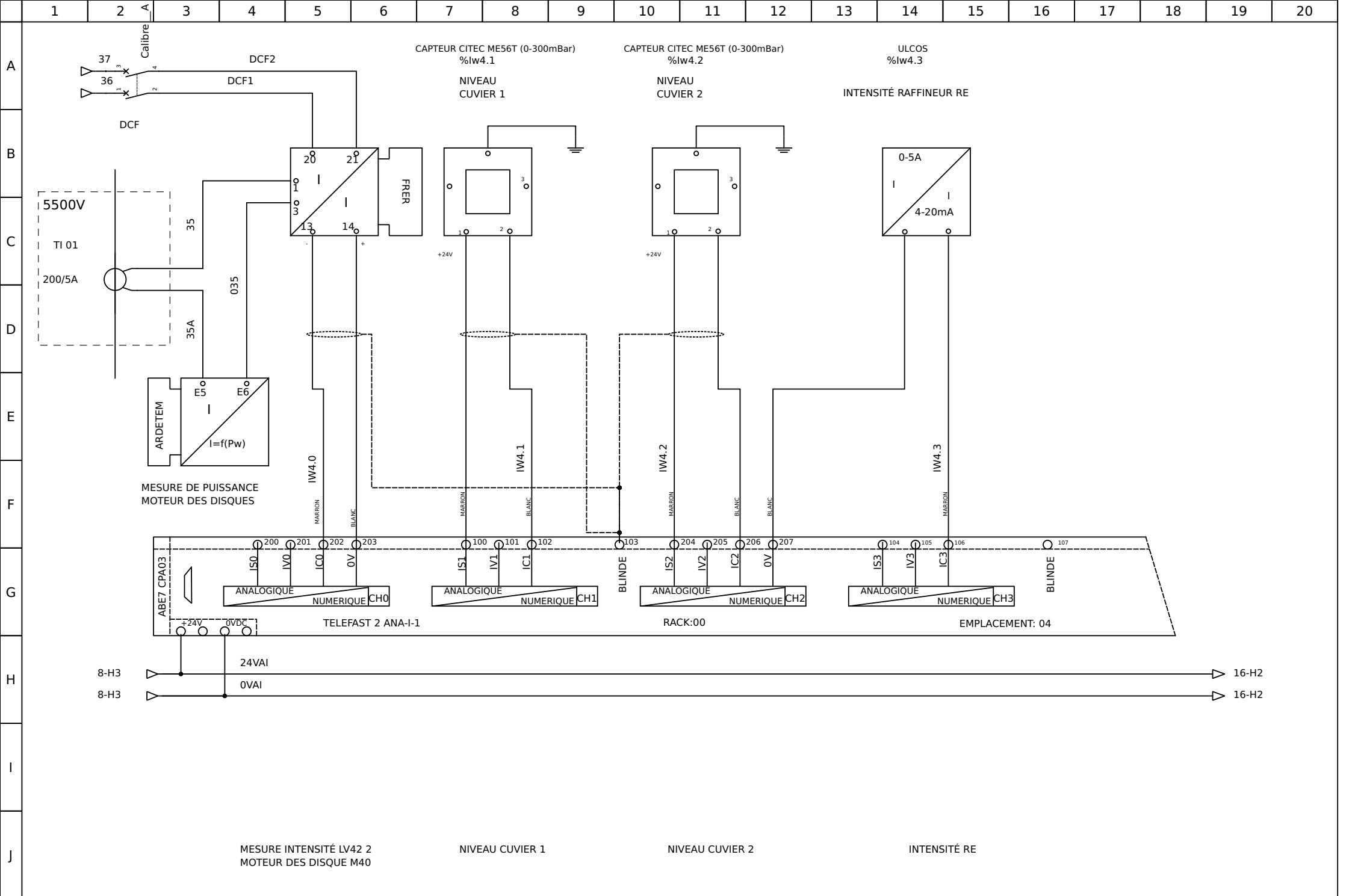

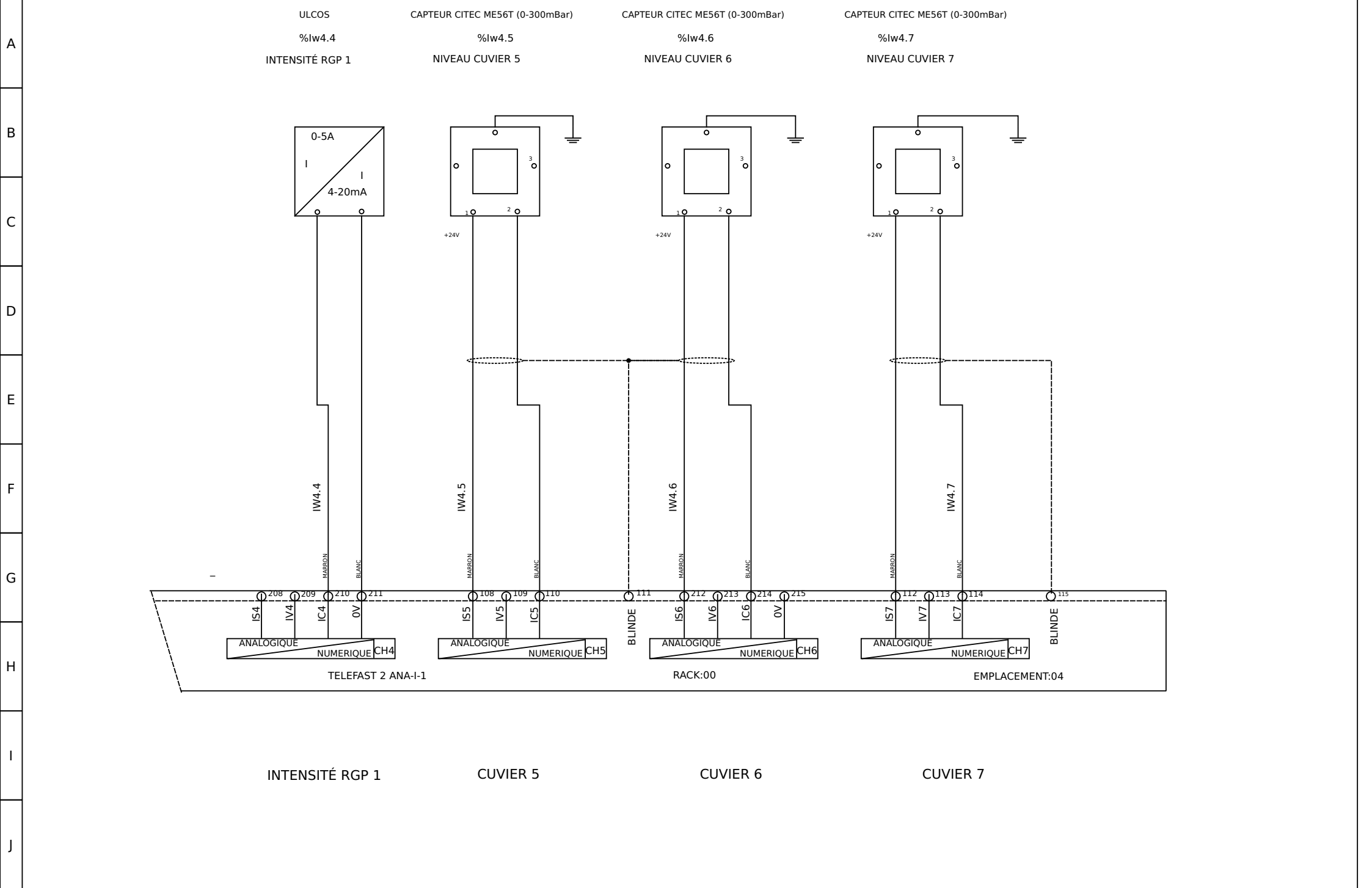

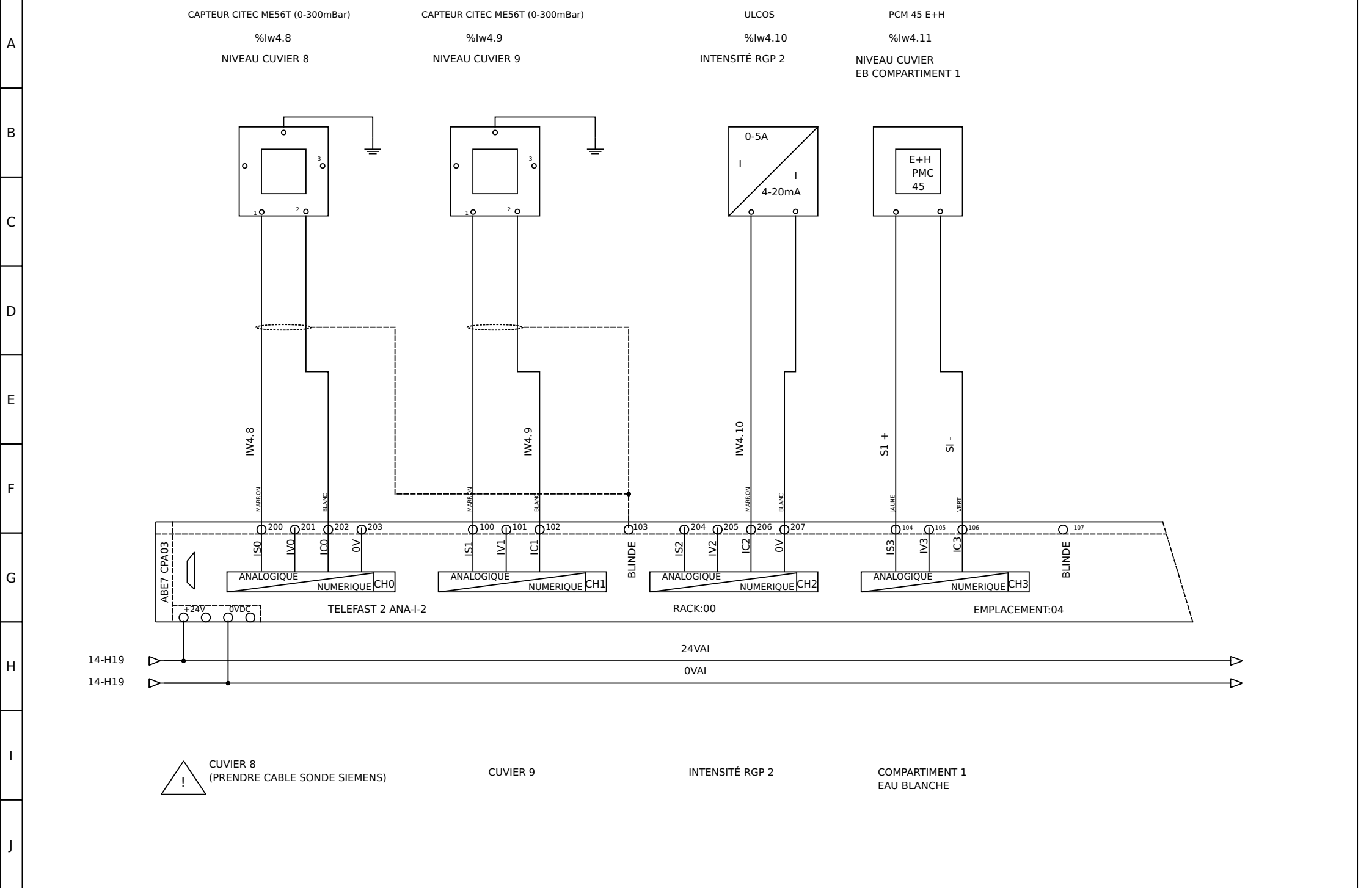



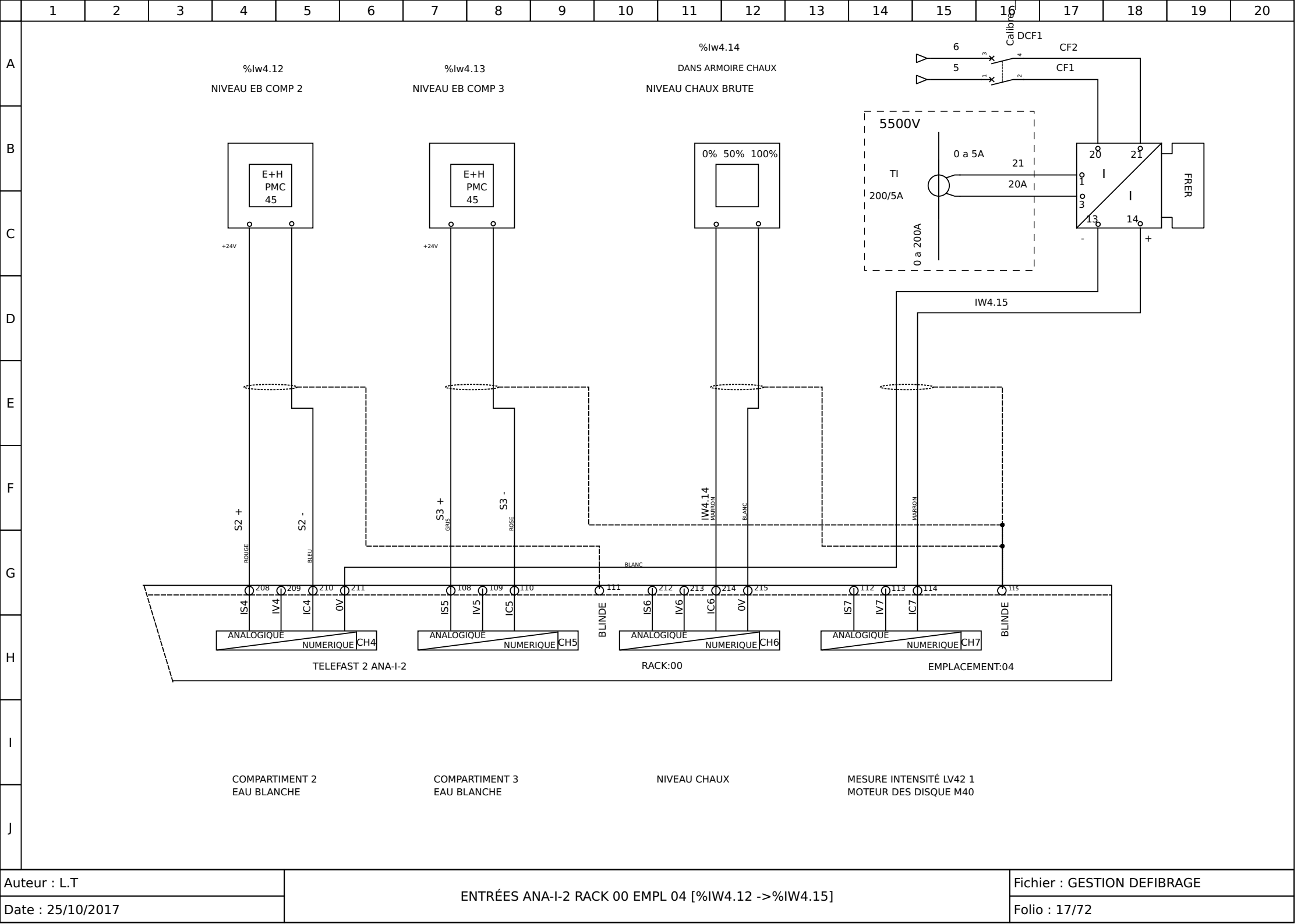

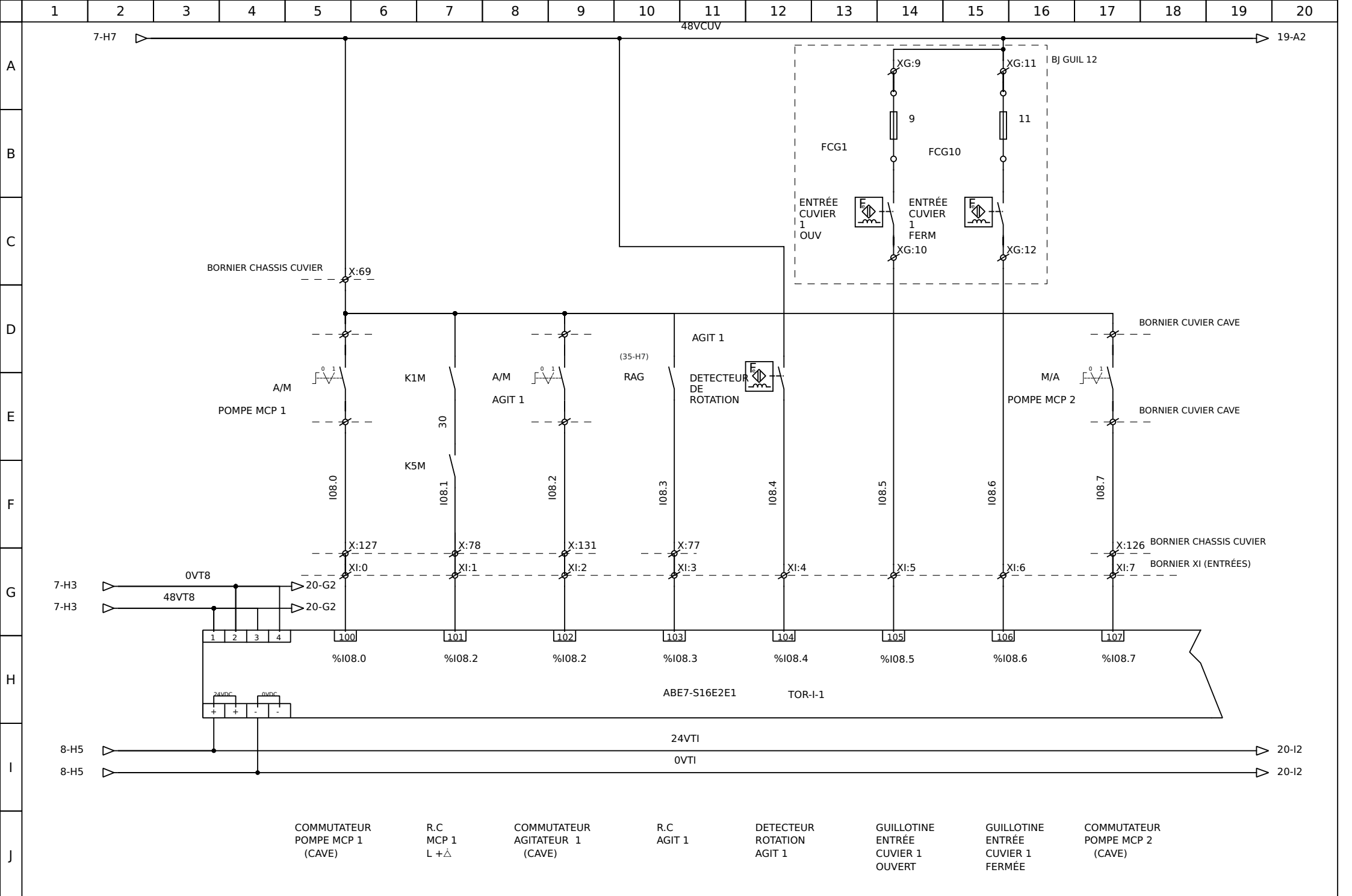

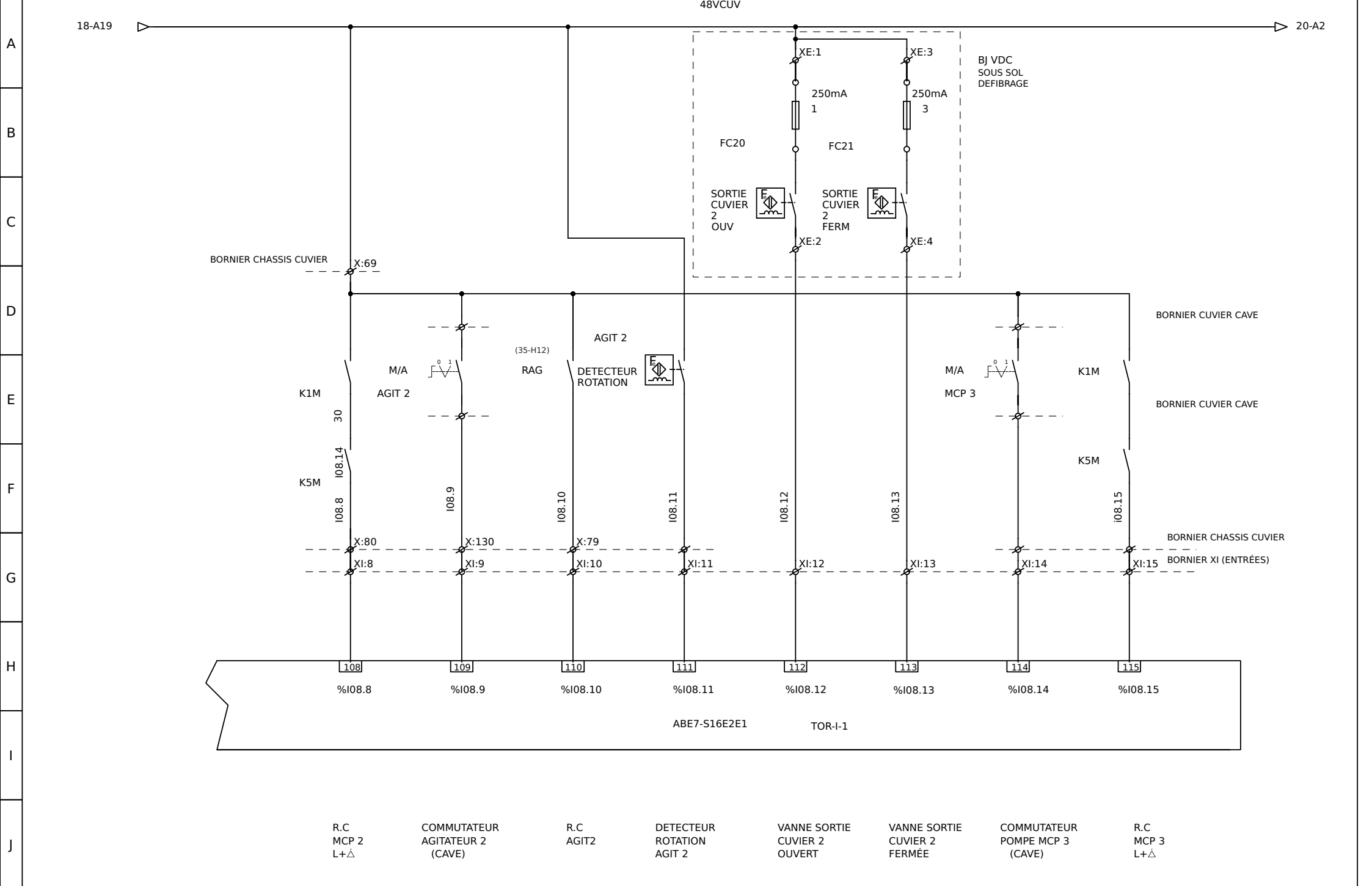

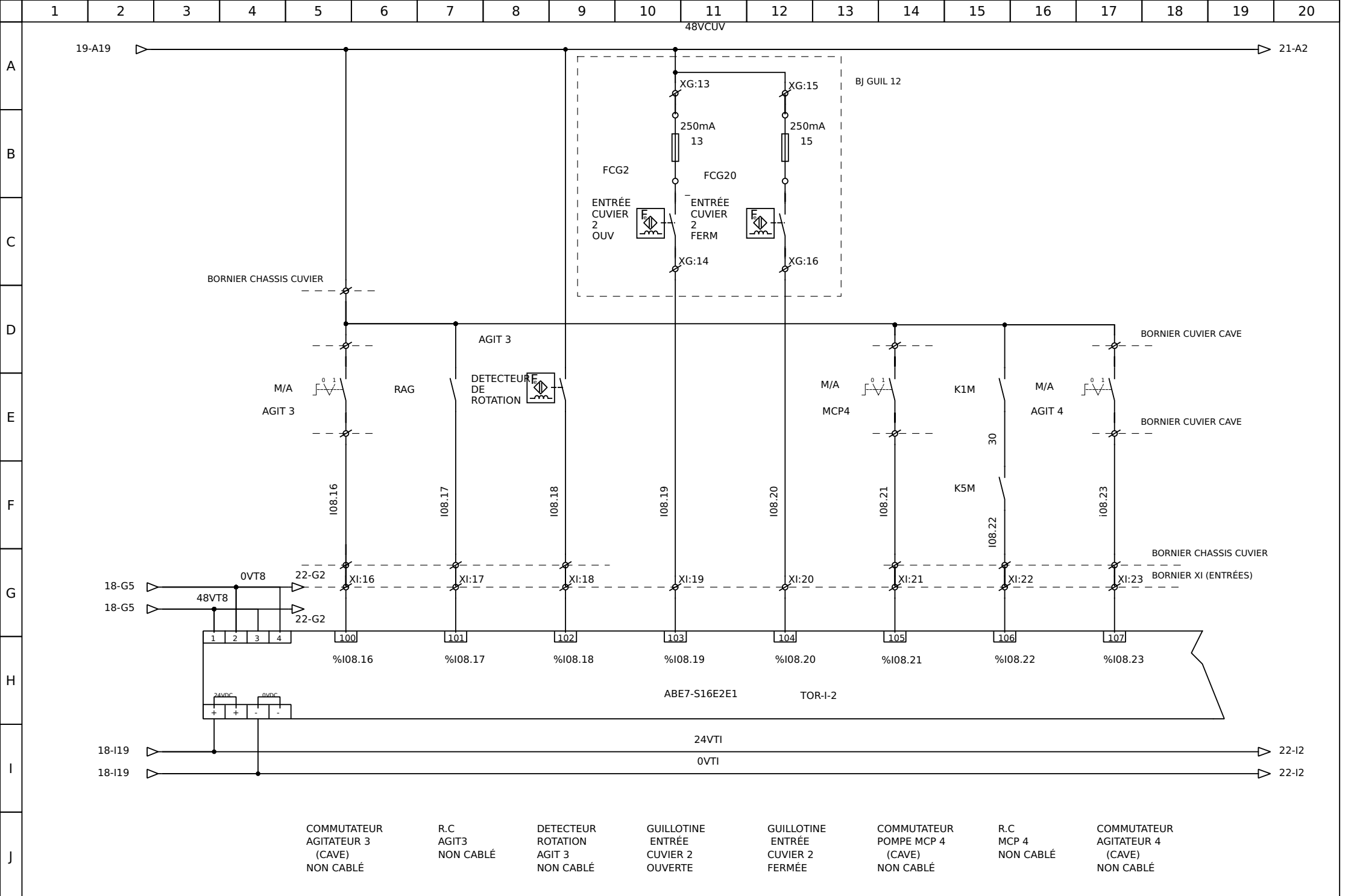

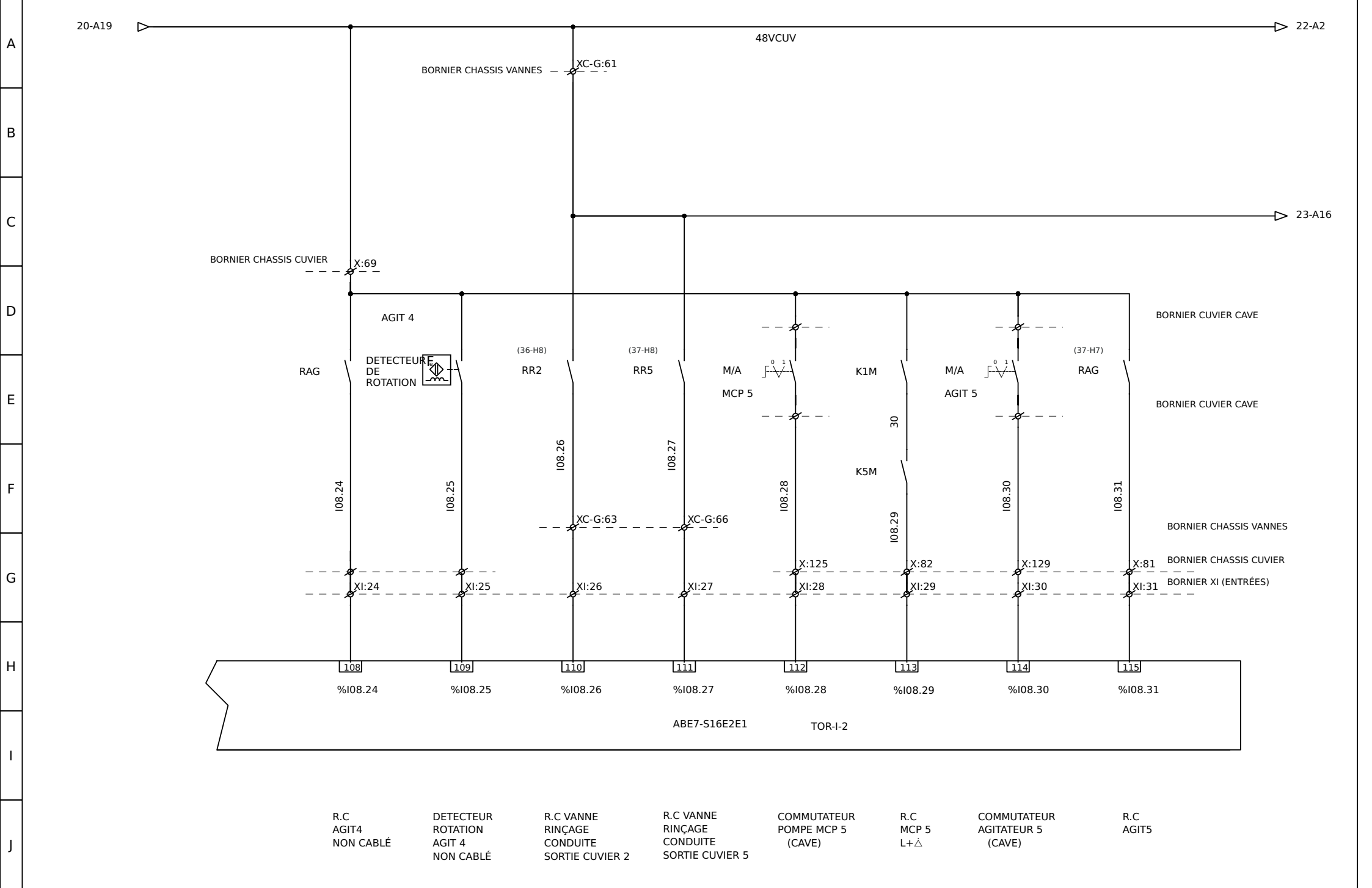

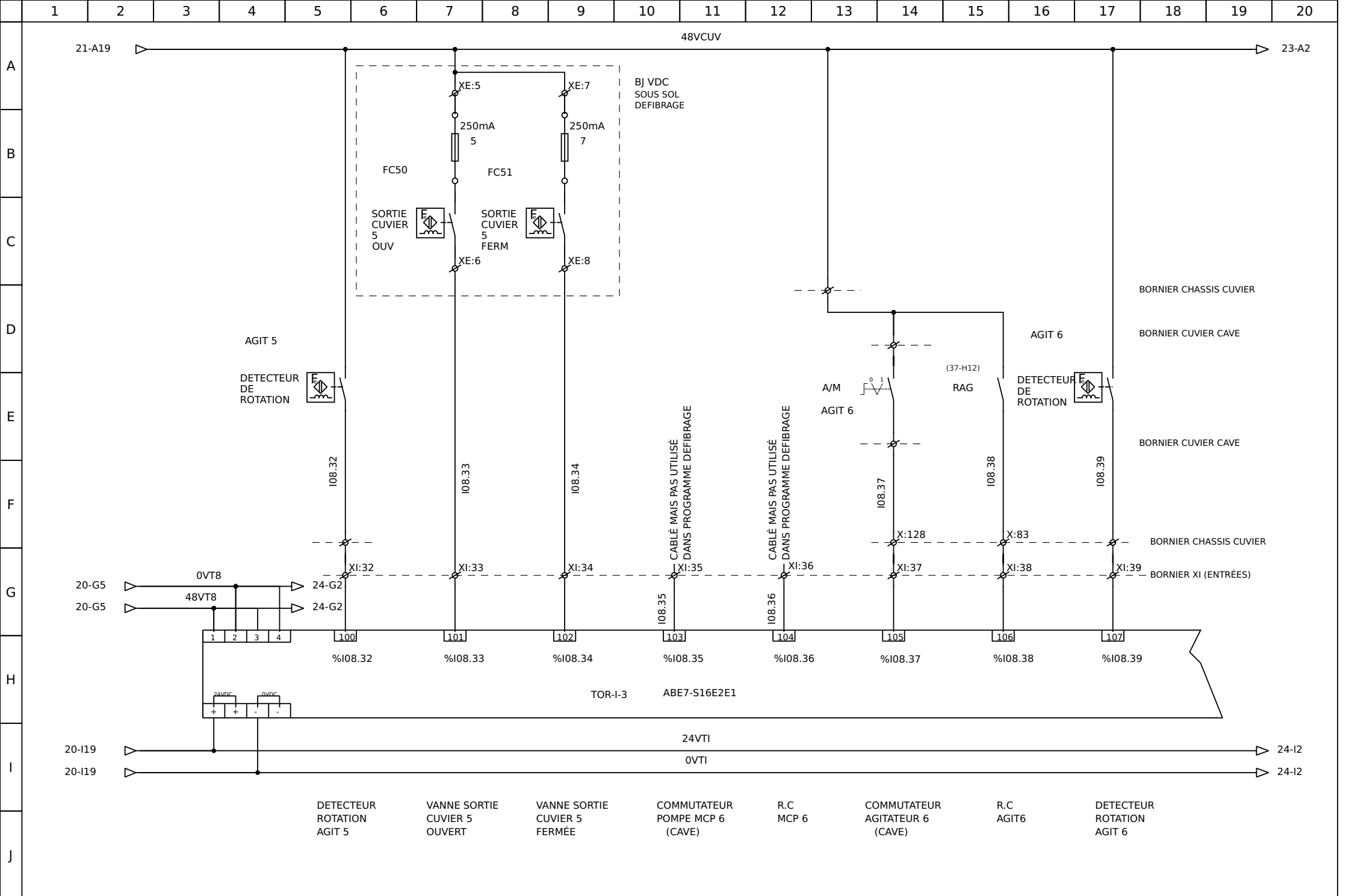

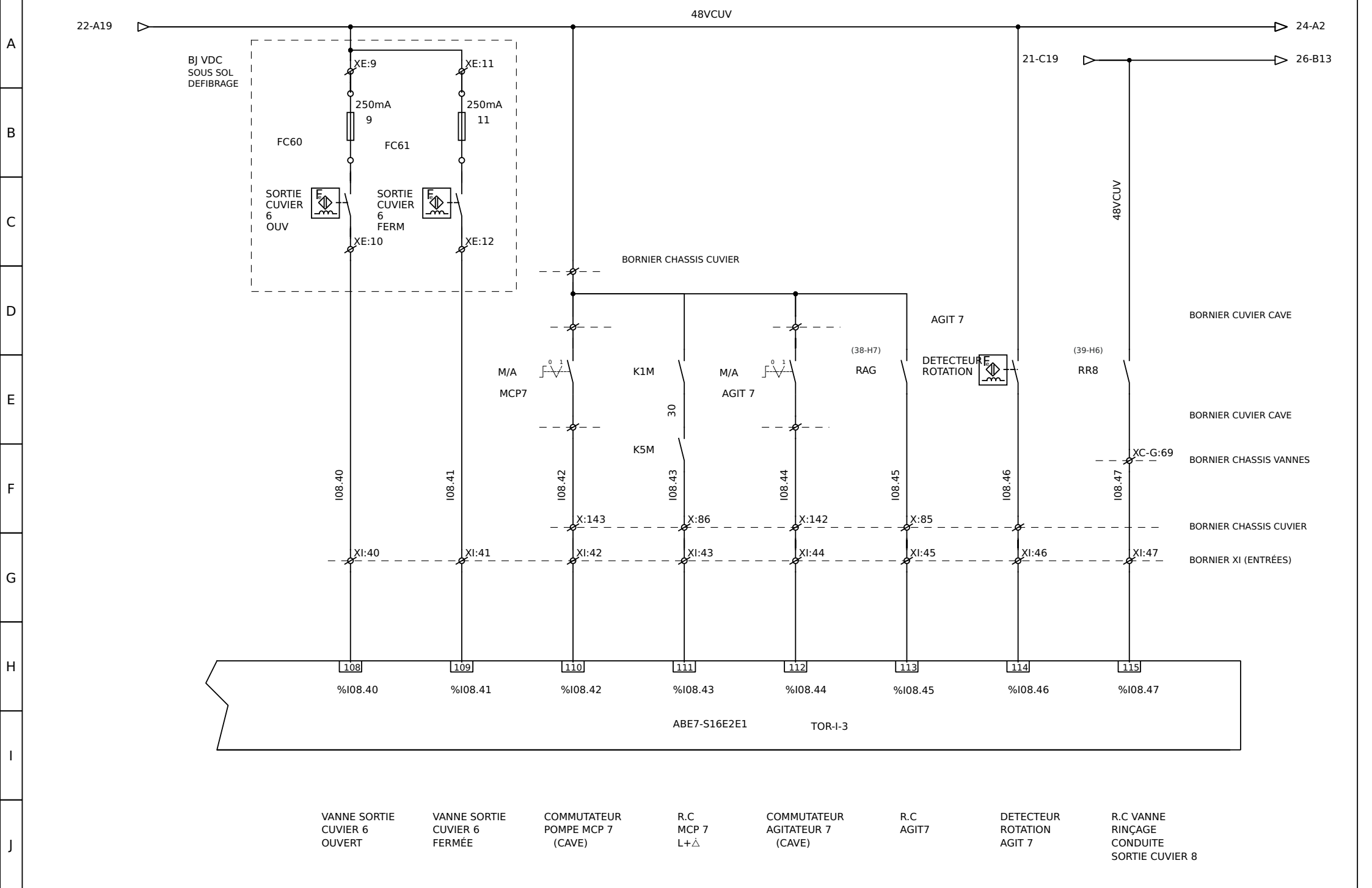

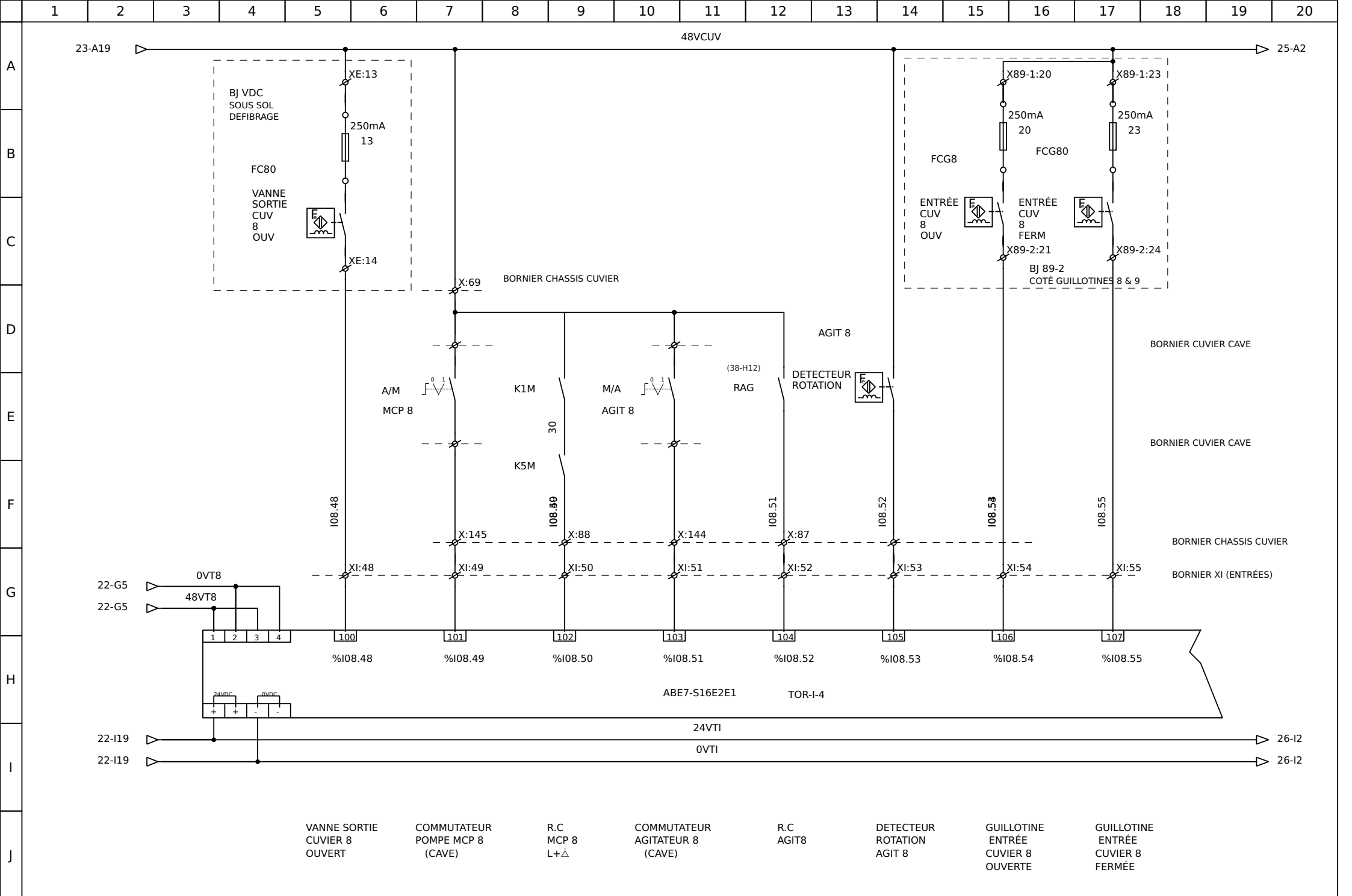



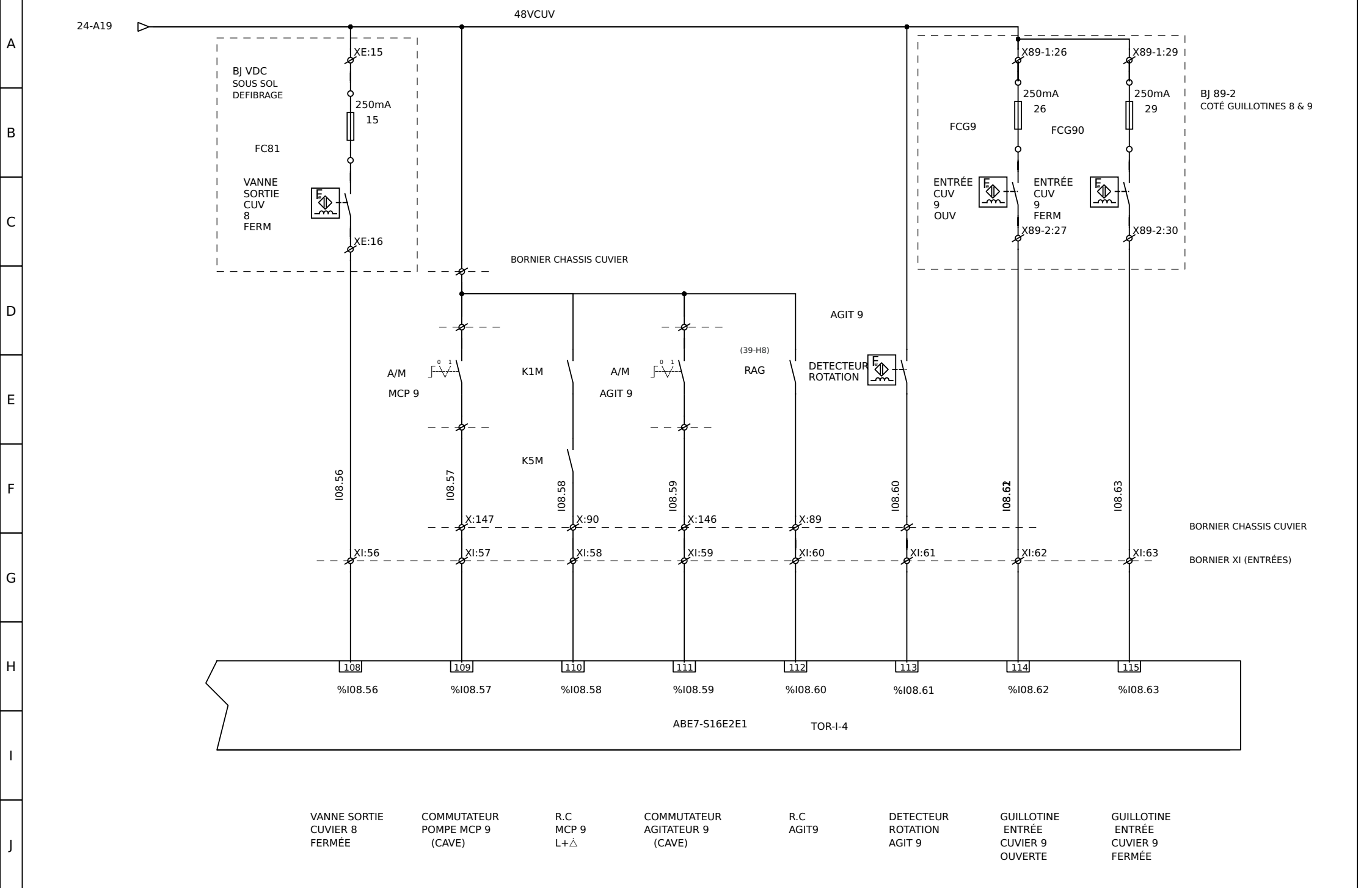

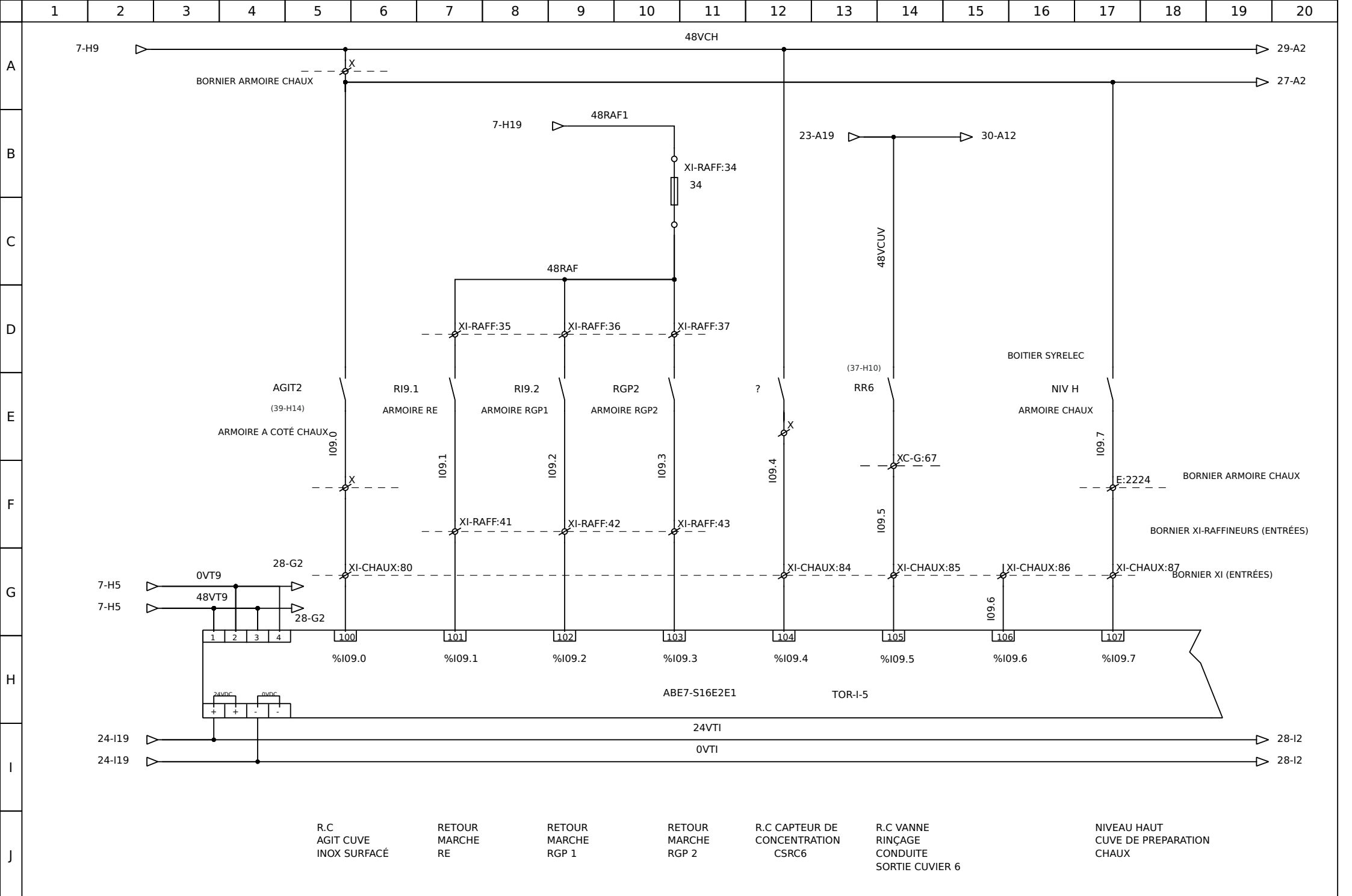

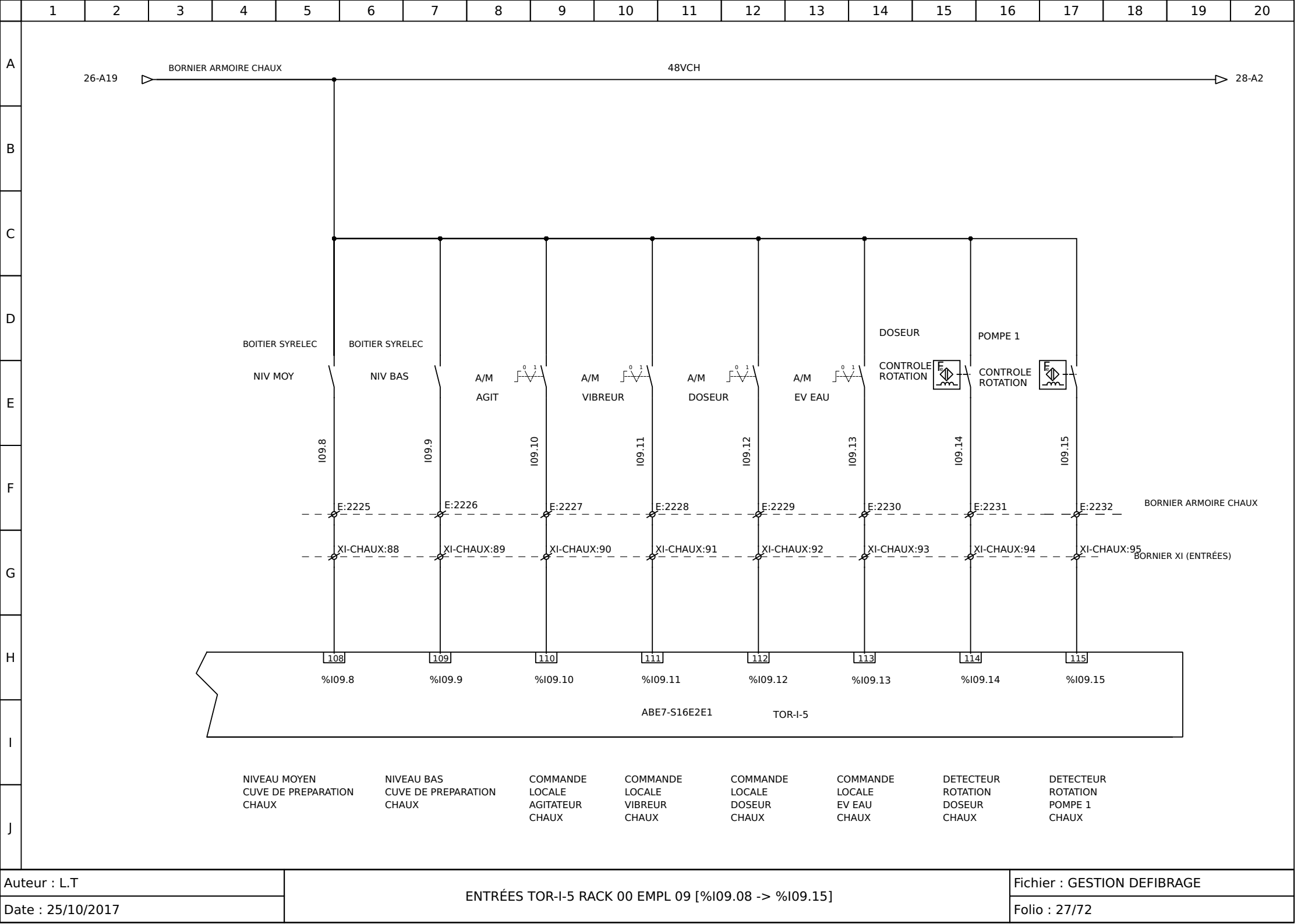

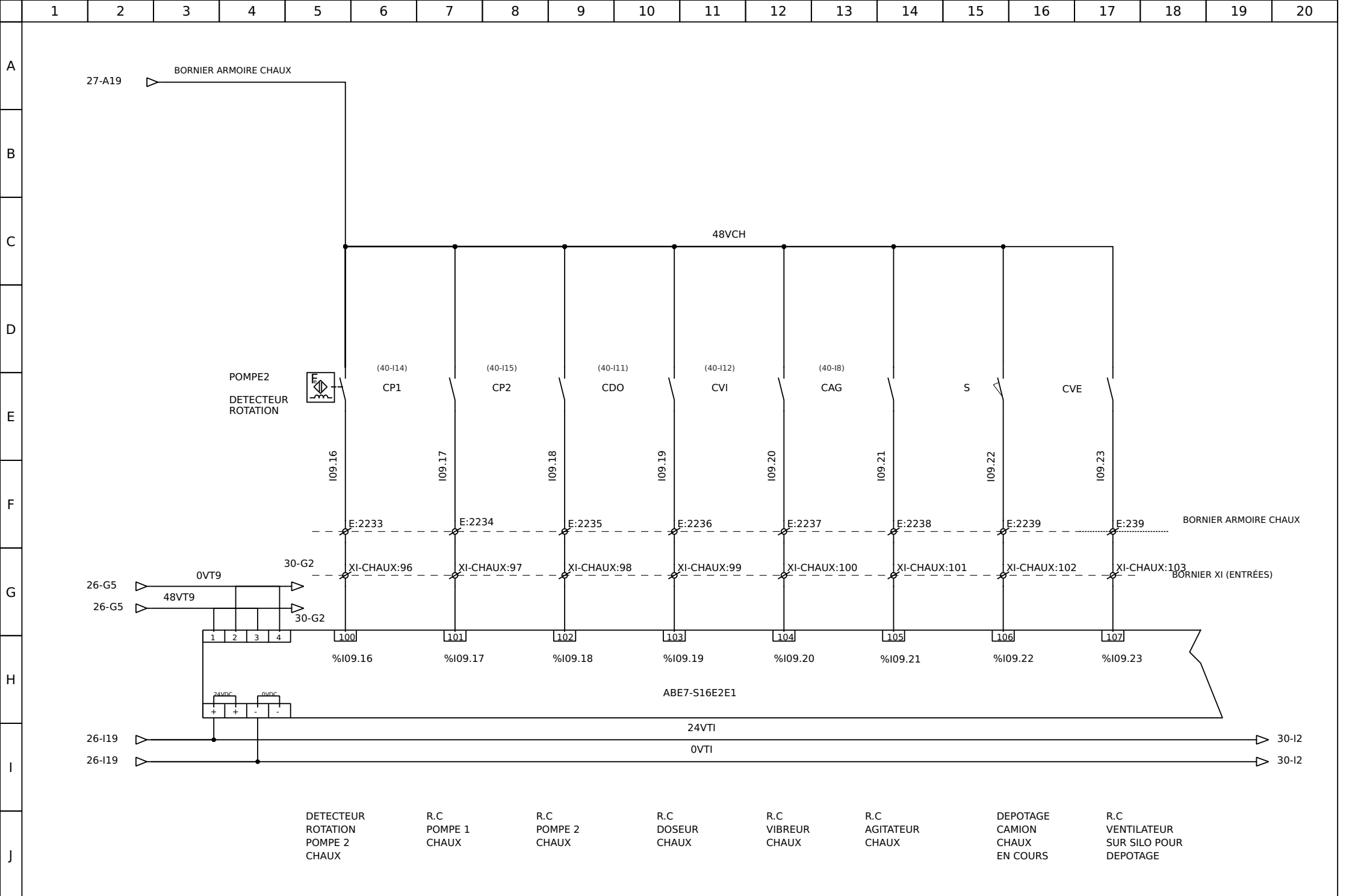

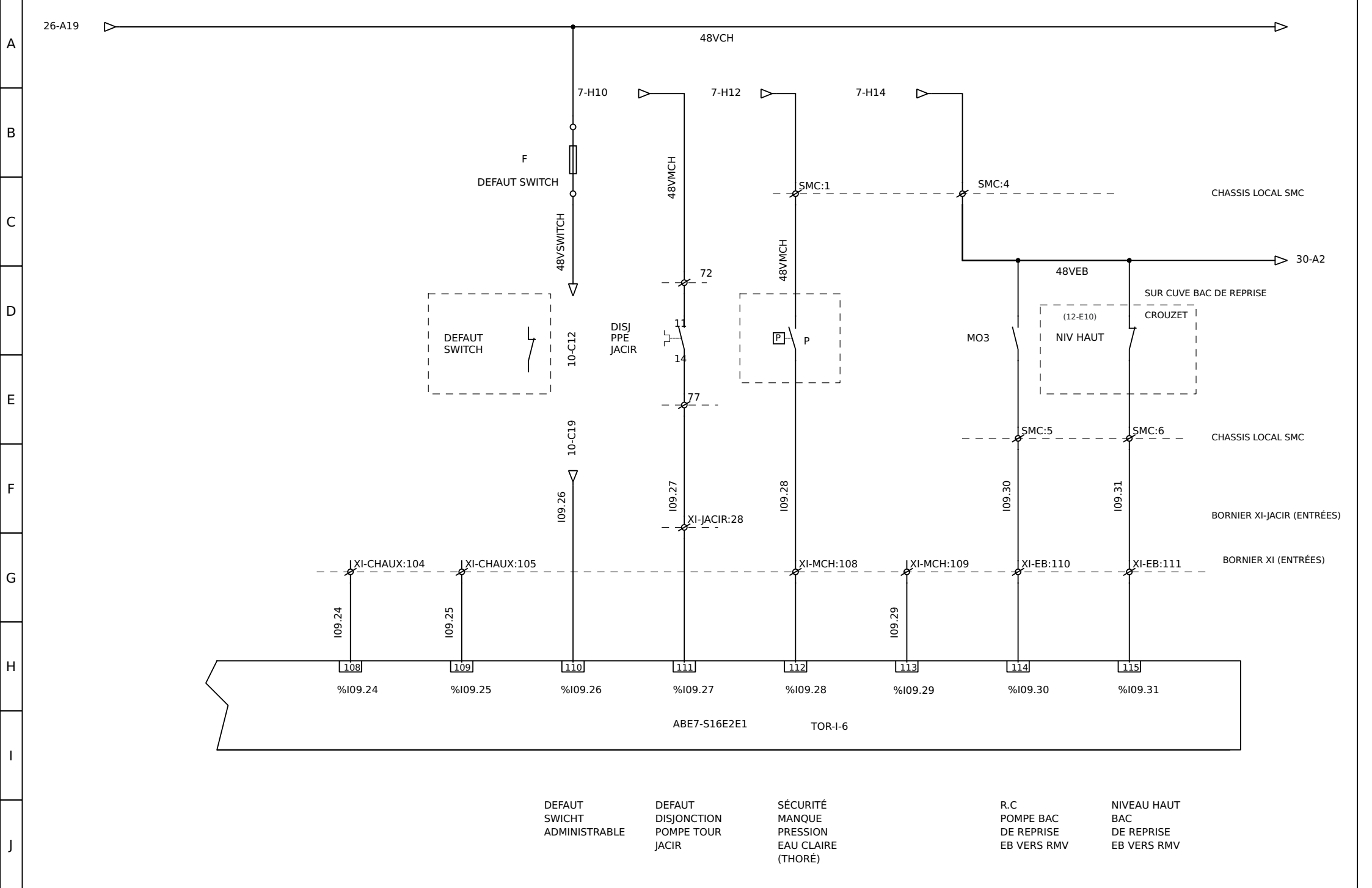

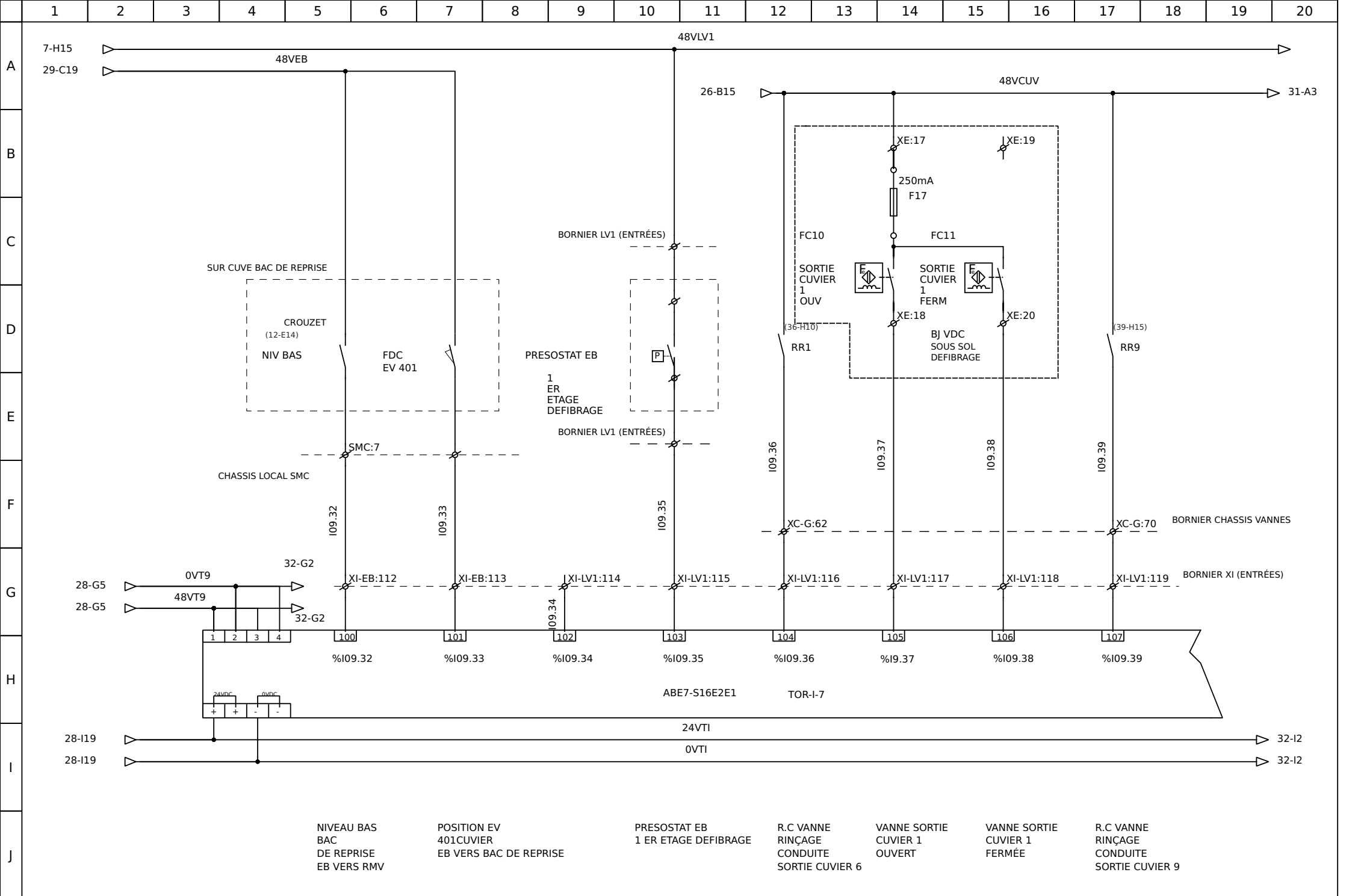

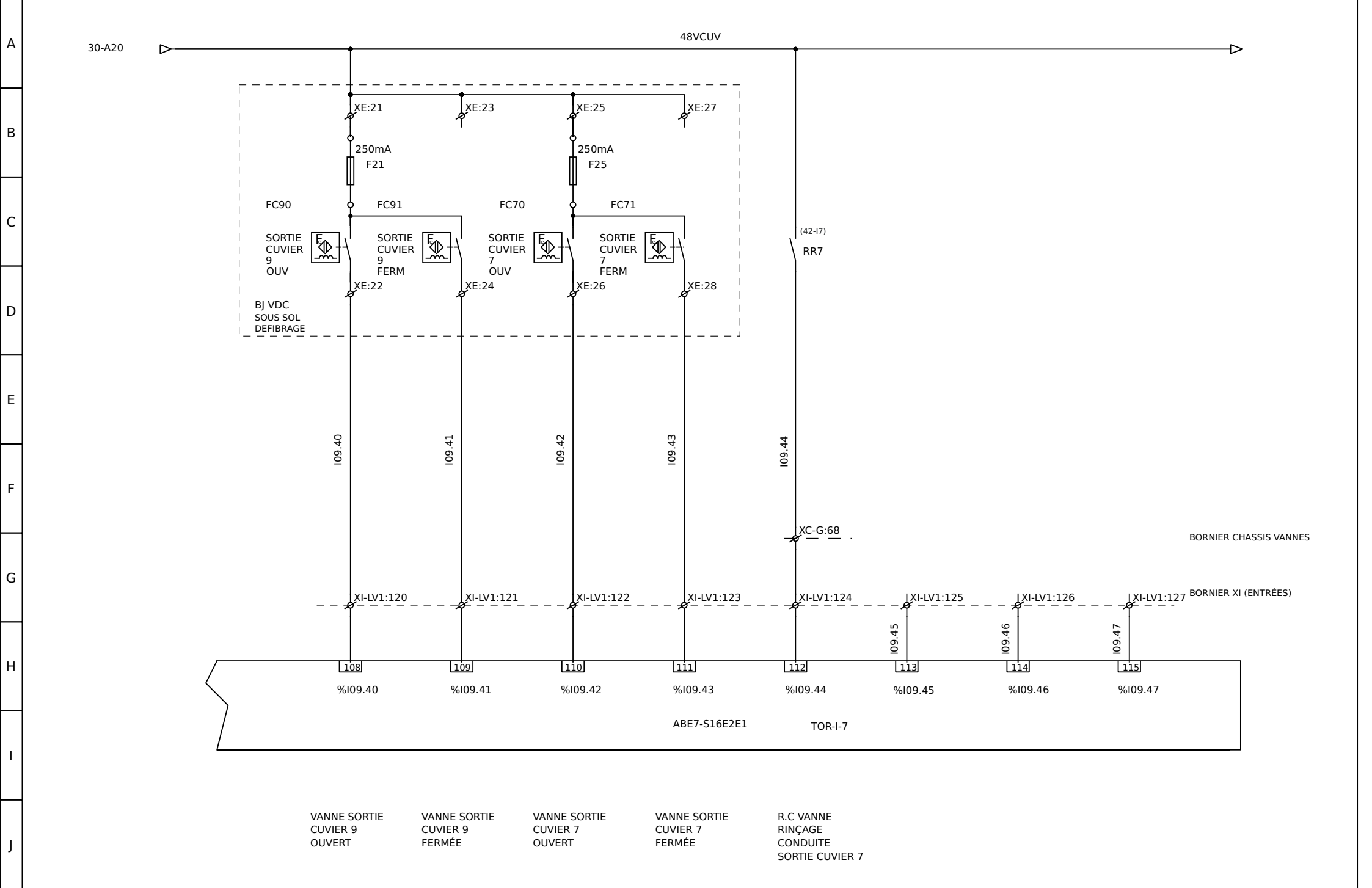

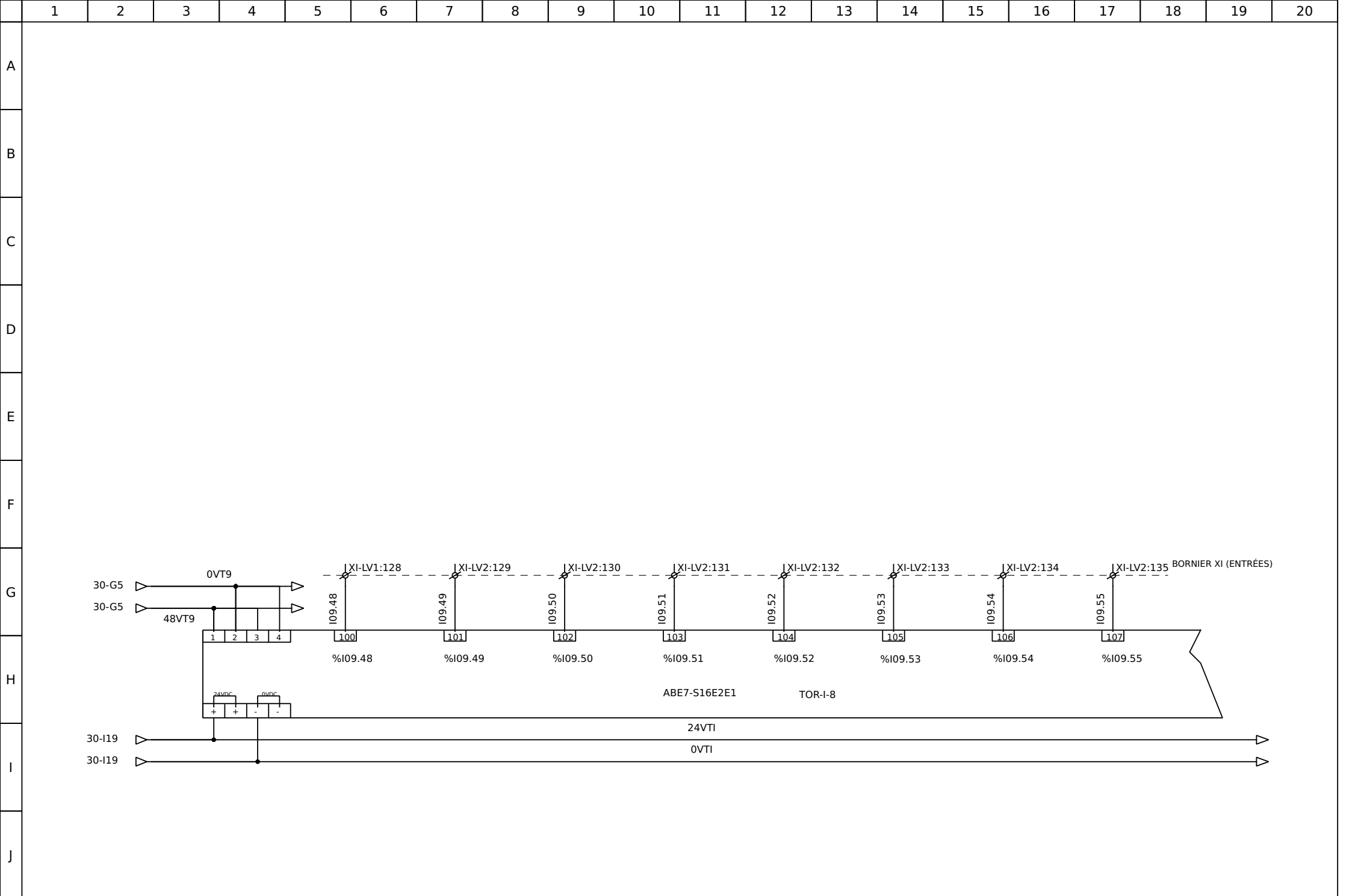



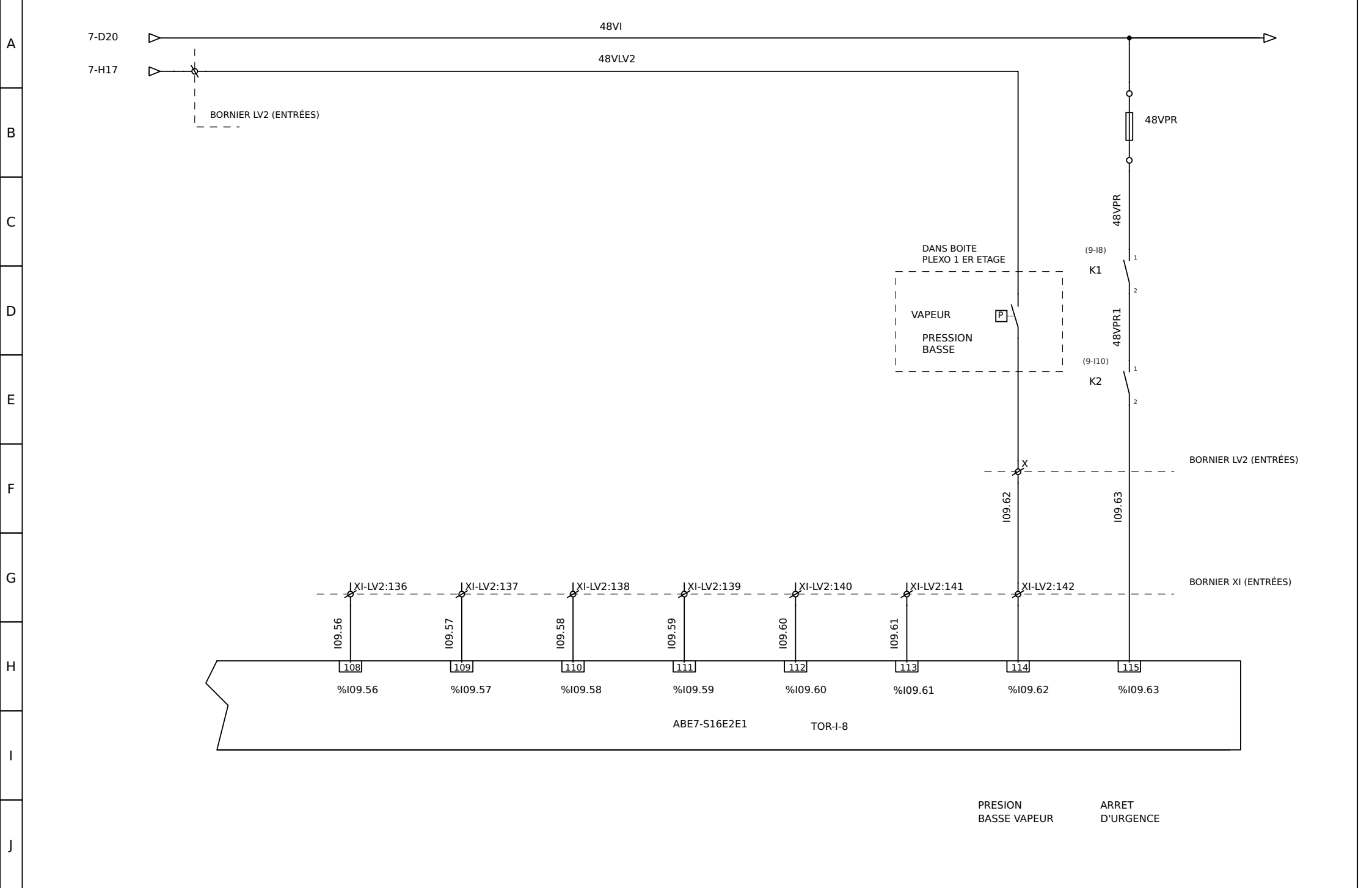

	1	2	3	4	5	6	7	8	9	10	11	12	13	14	15	16	17	18	19	20	
A																					
B																					
C																					
D																					
E	<h1>FOLIO RESERVE</h1>																				
F																					
G																					
H																					
I																					
J																					
Auteur : L.T					FOLIO RESERVE												Fichier : GESTION DEFIBRAGE				
Date : 25/10/2017																	Folio : 34/72				

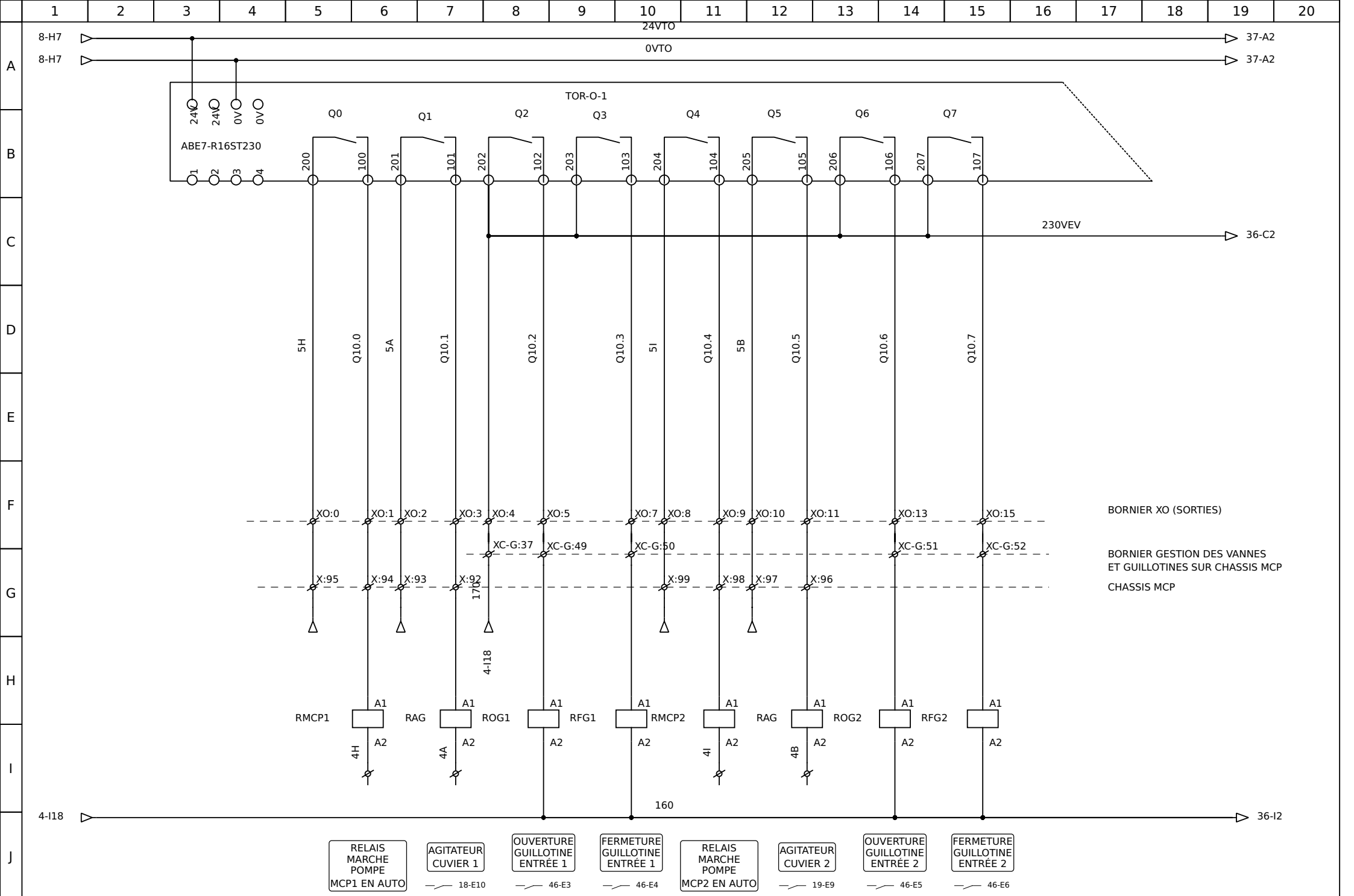

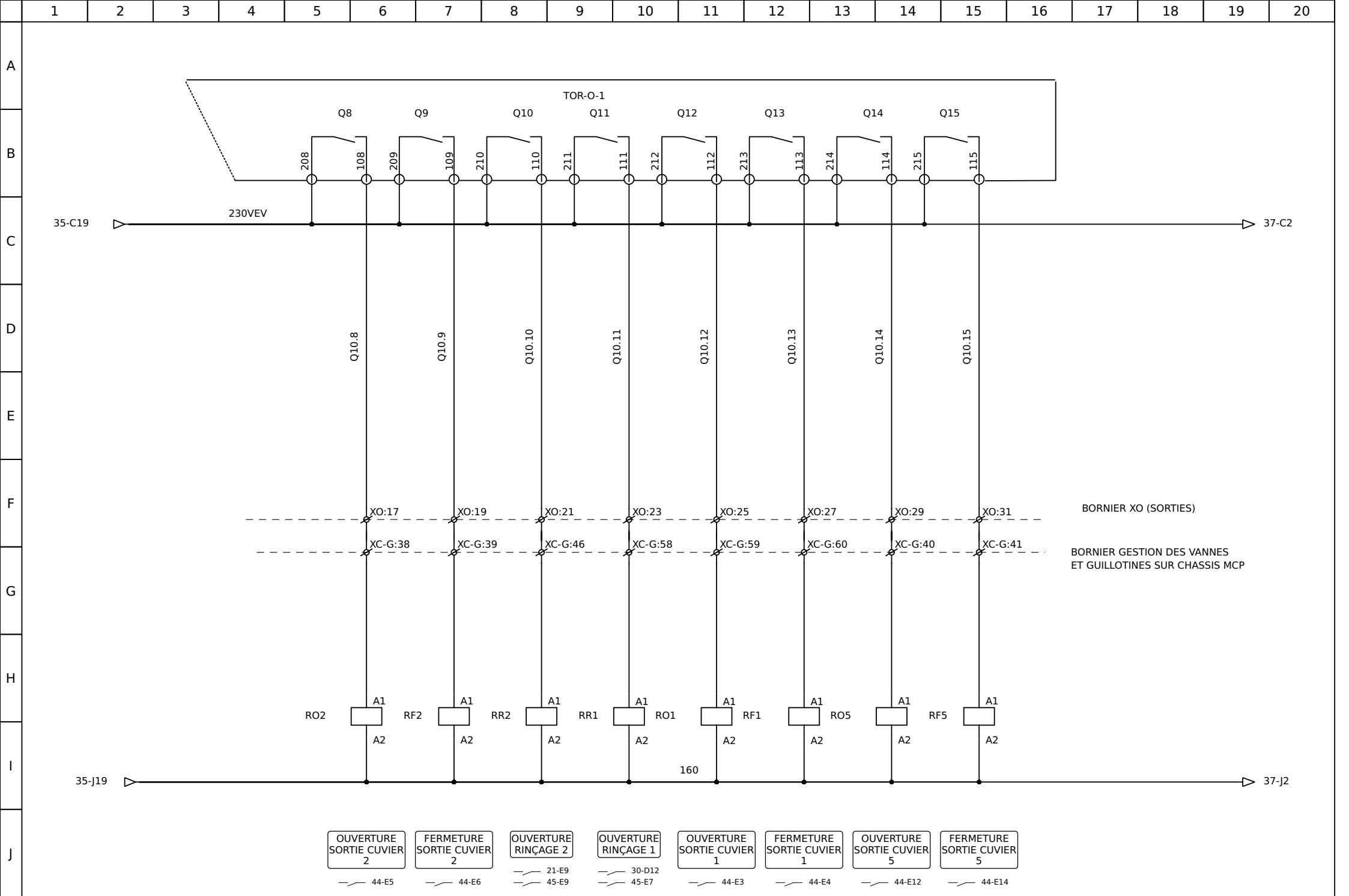

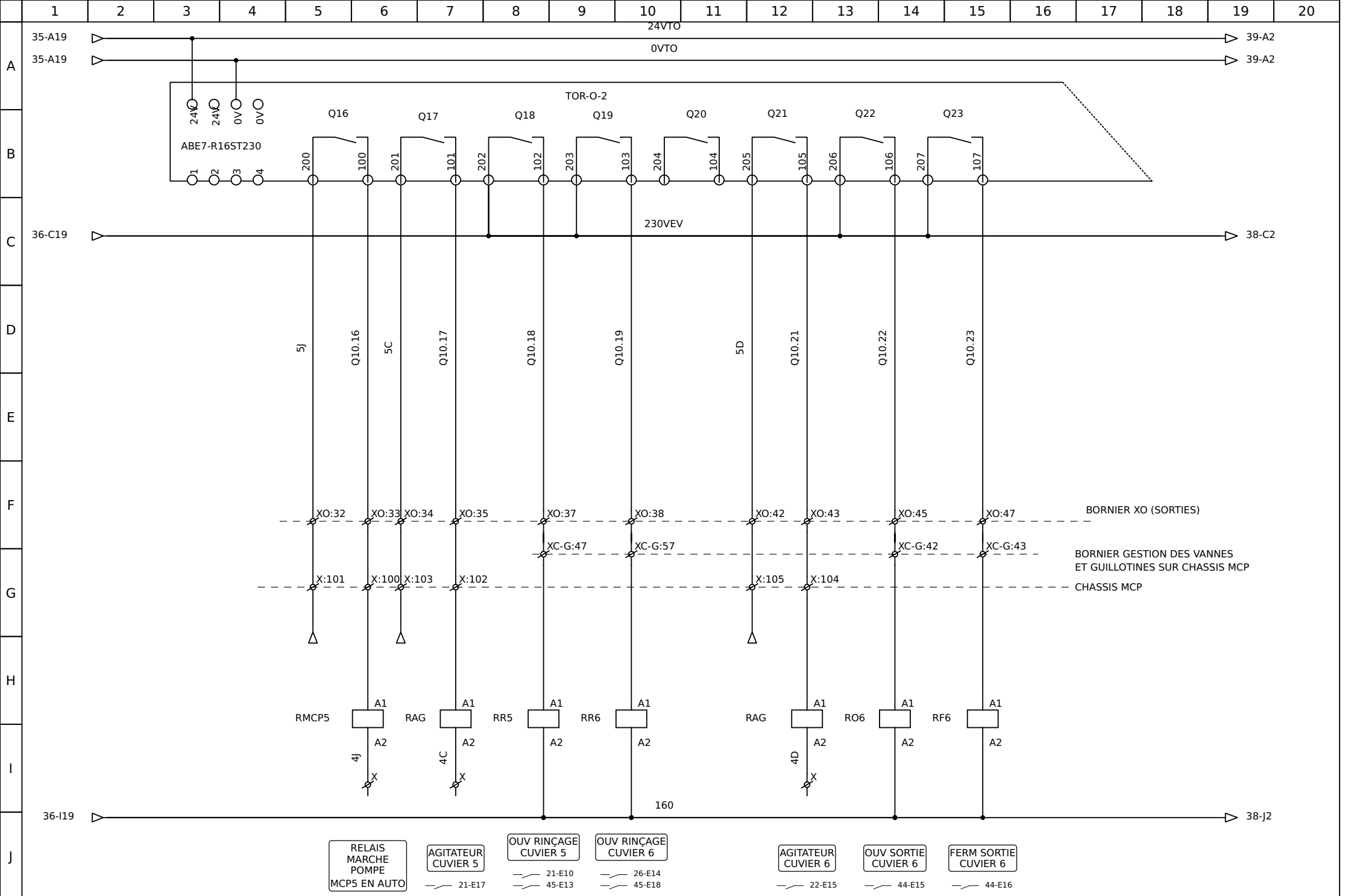

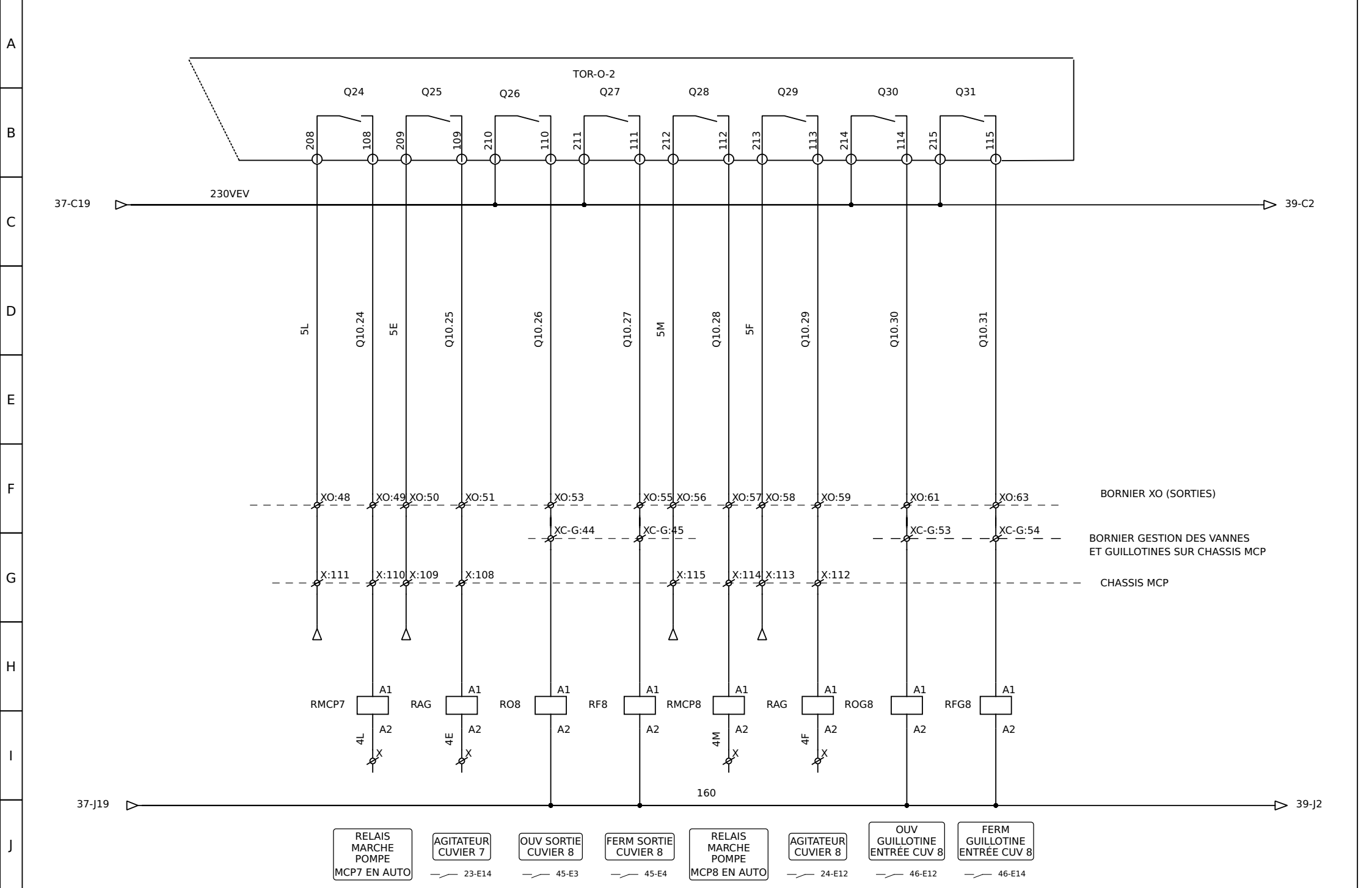

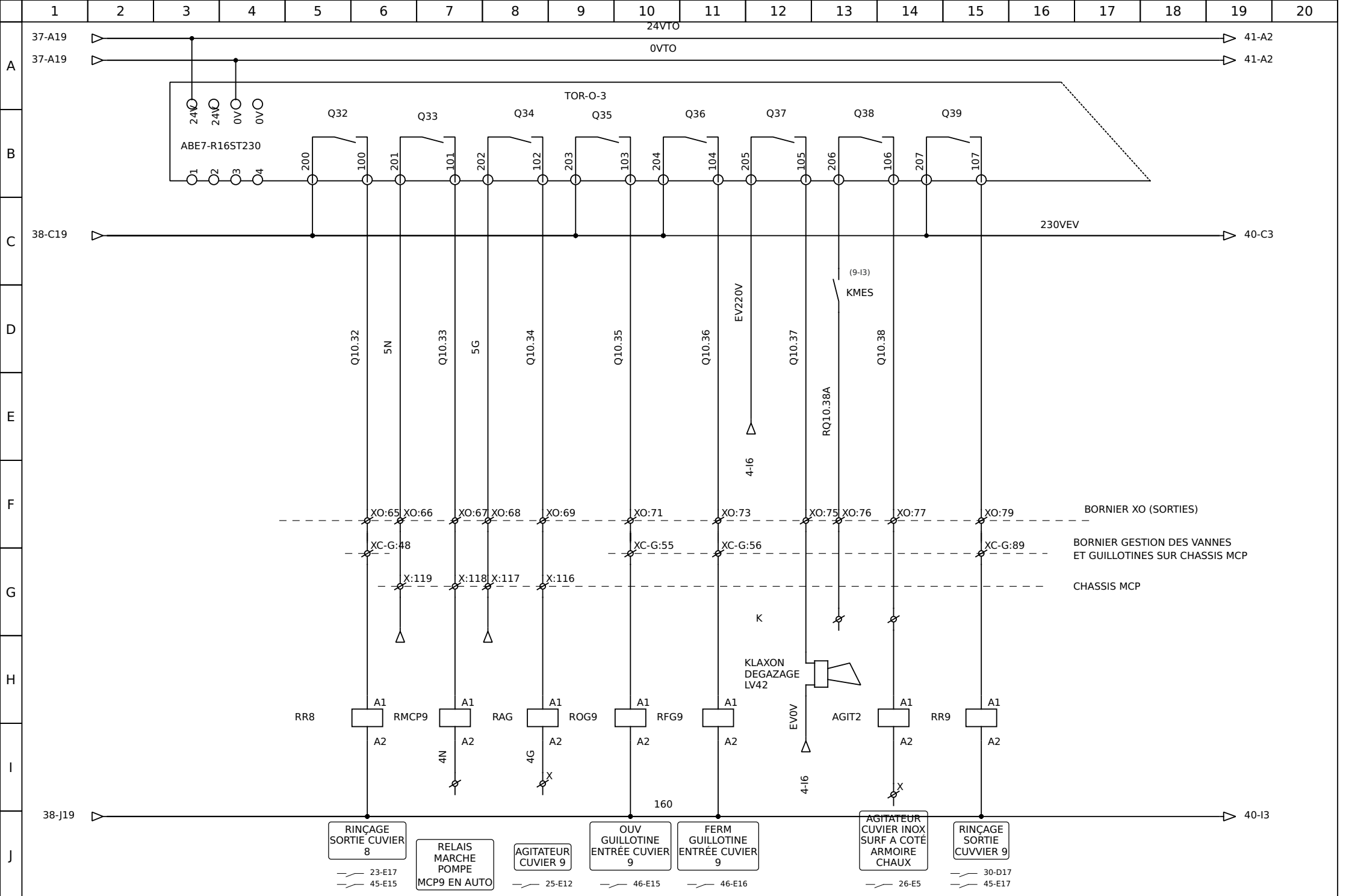

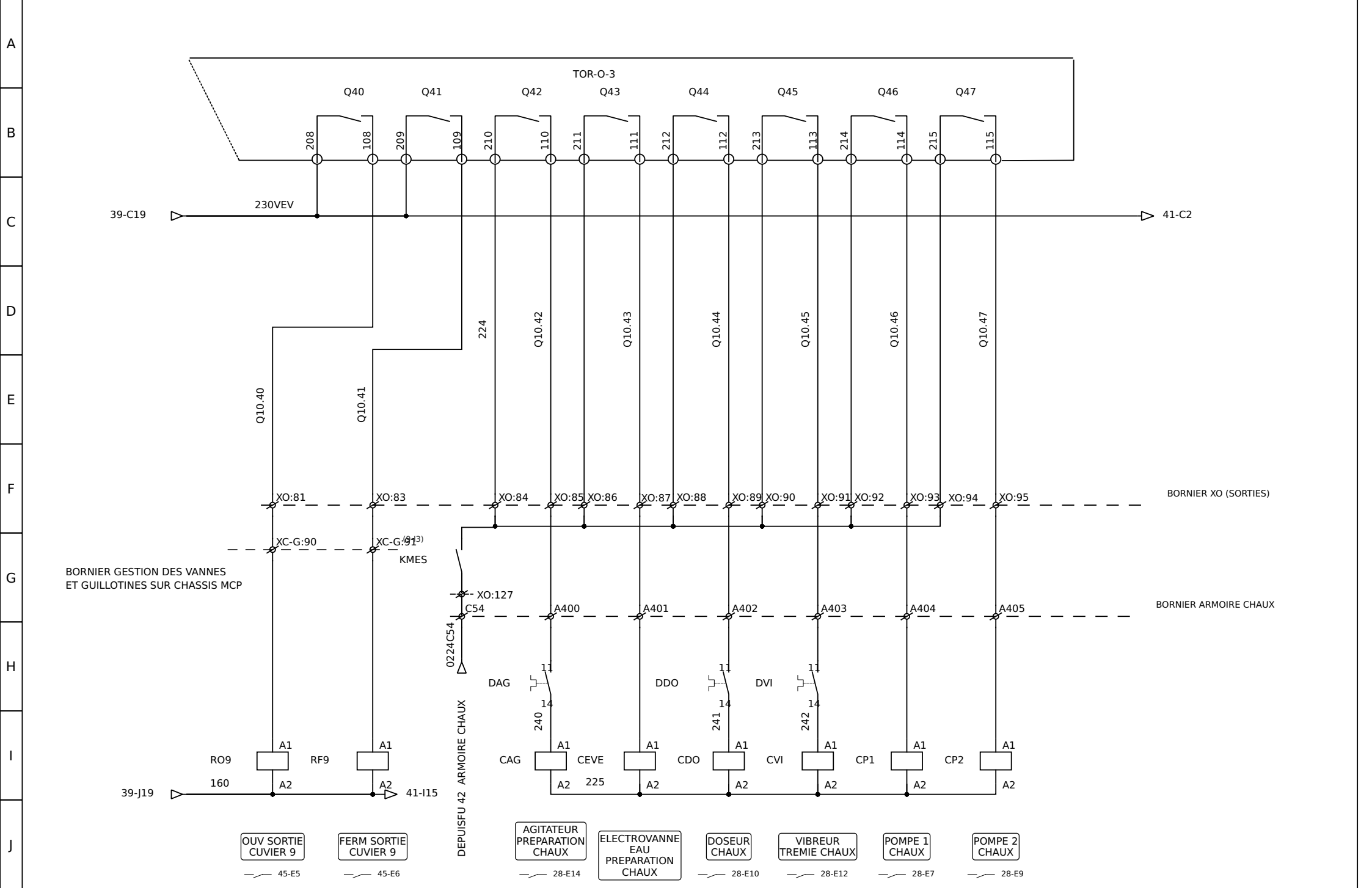





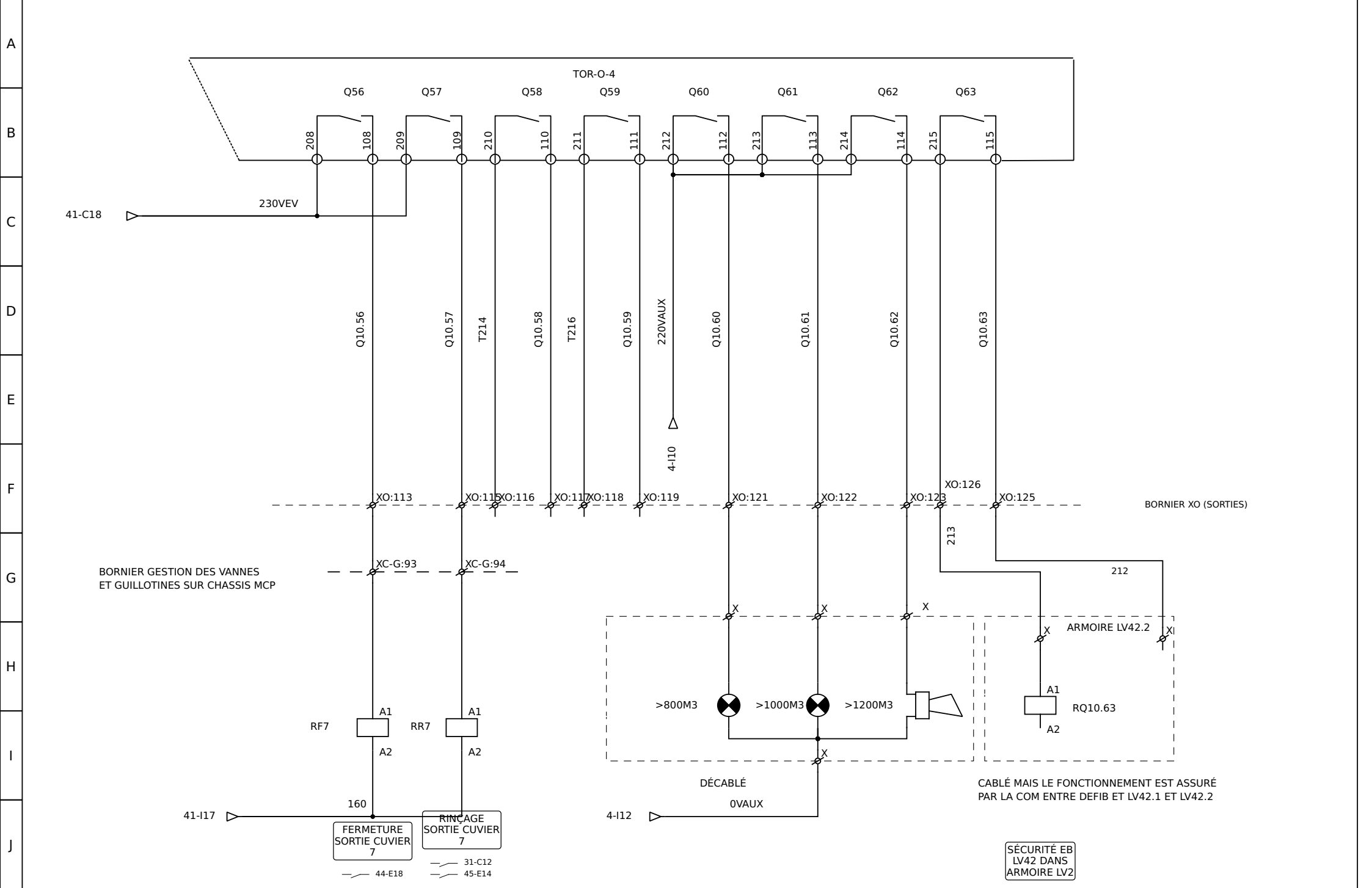

1 2 3 4 5 6 7 8 9 10 11 12 13 14 15 16 17 18 19 20

A

B

C

D

E

F

G

H

I

J

# FOLIO RESERVE

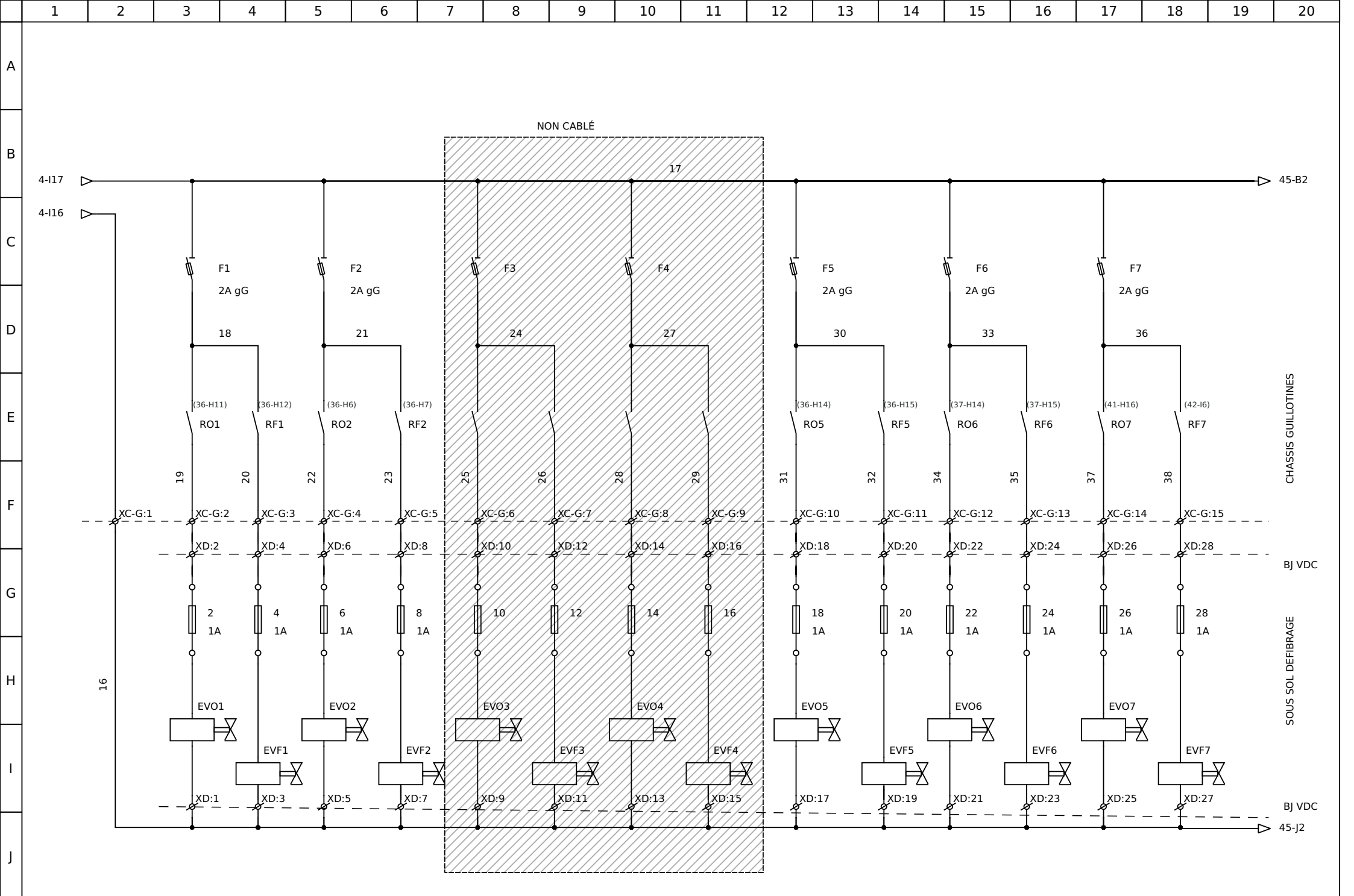

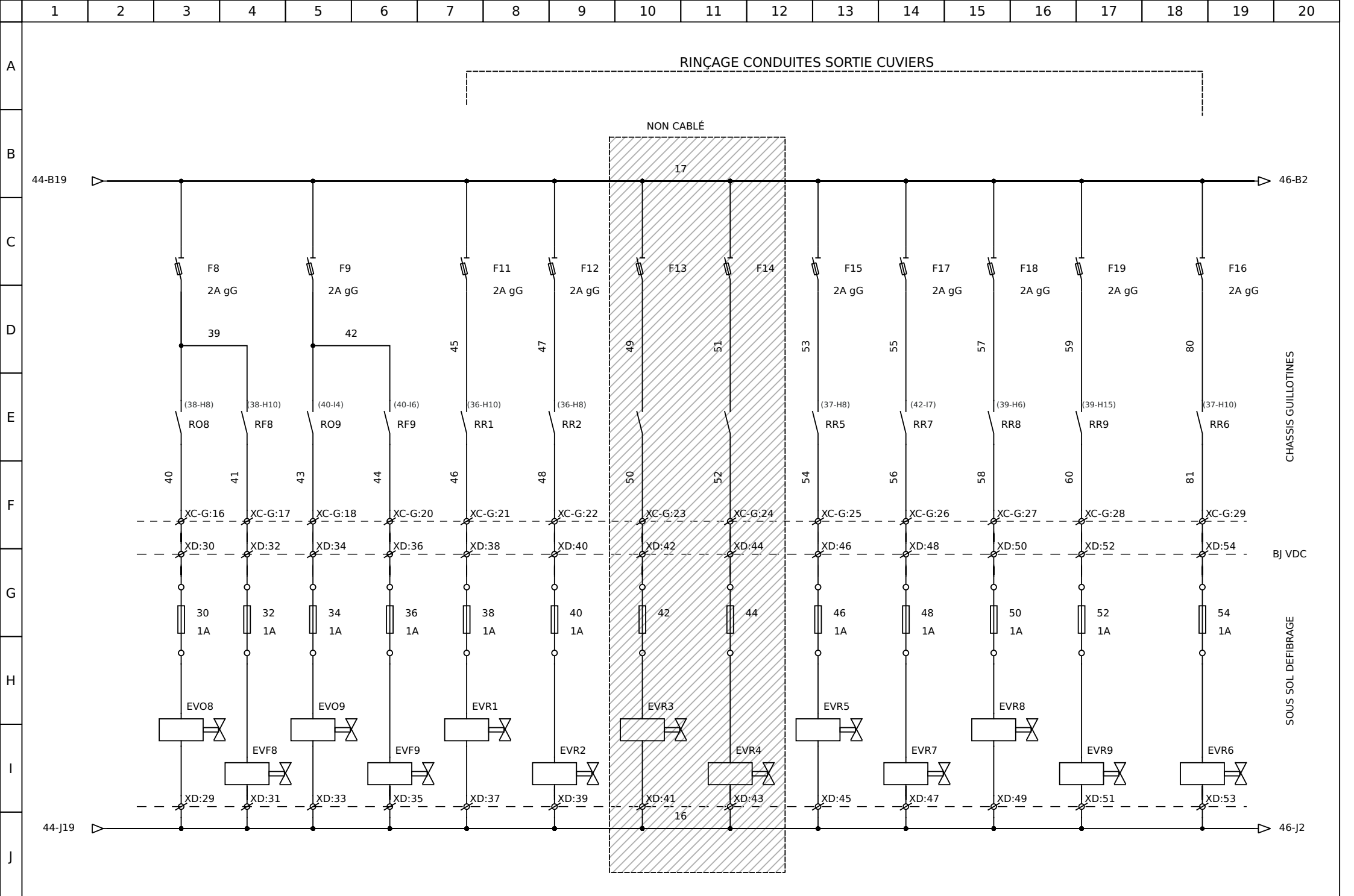

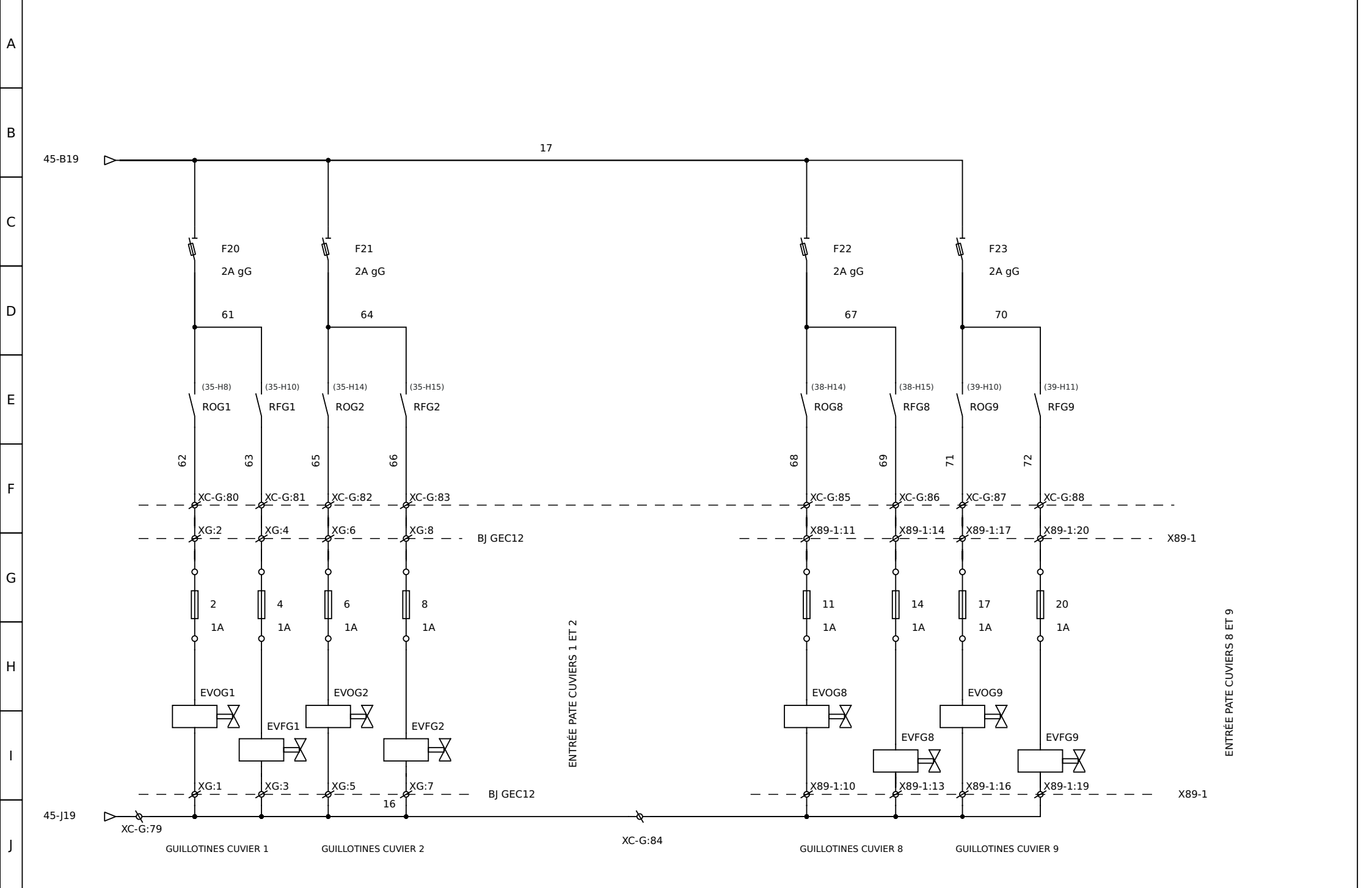

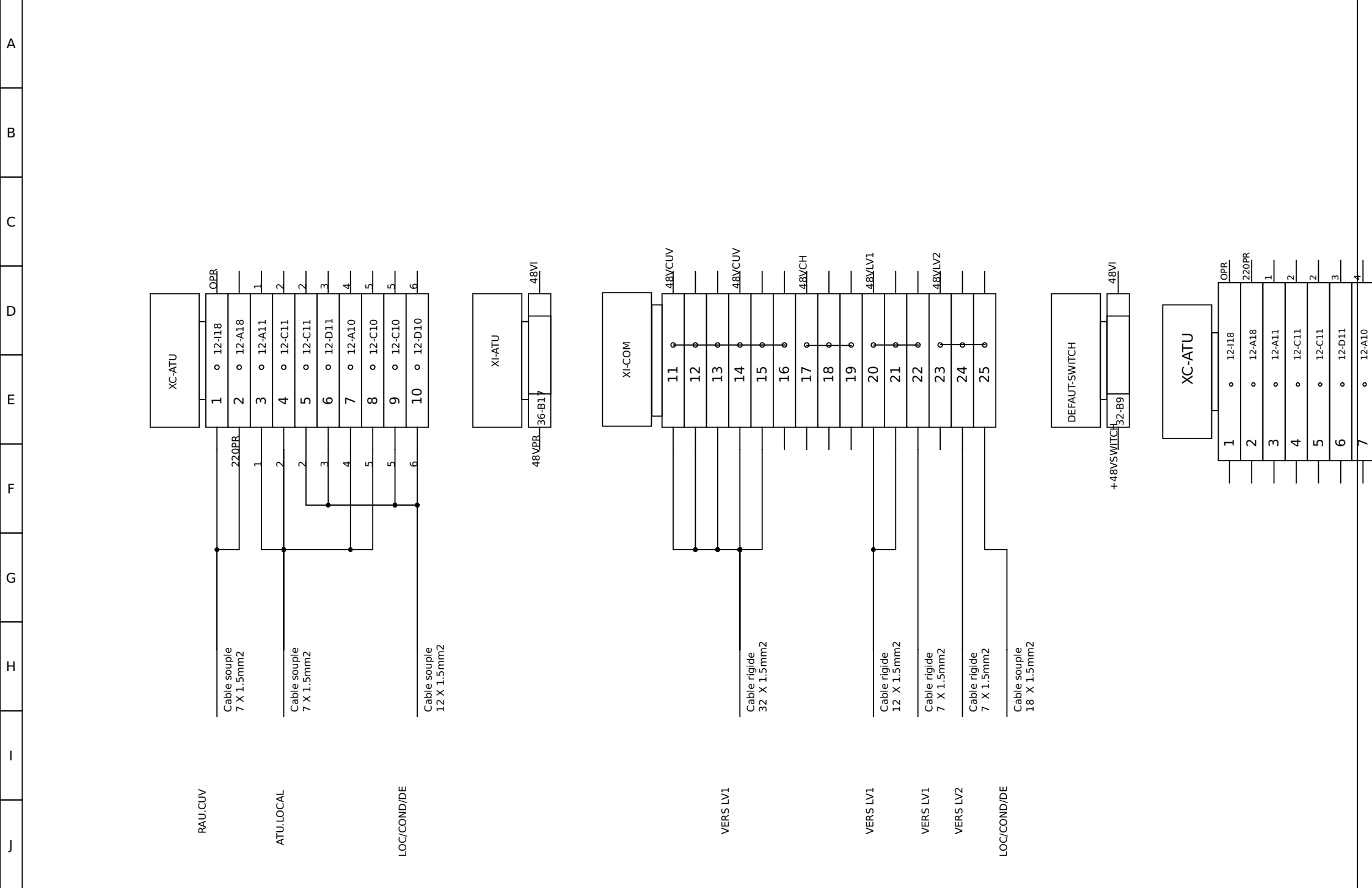

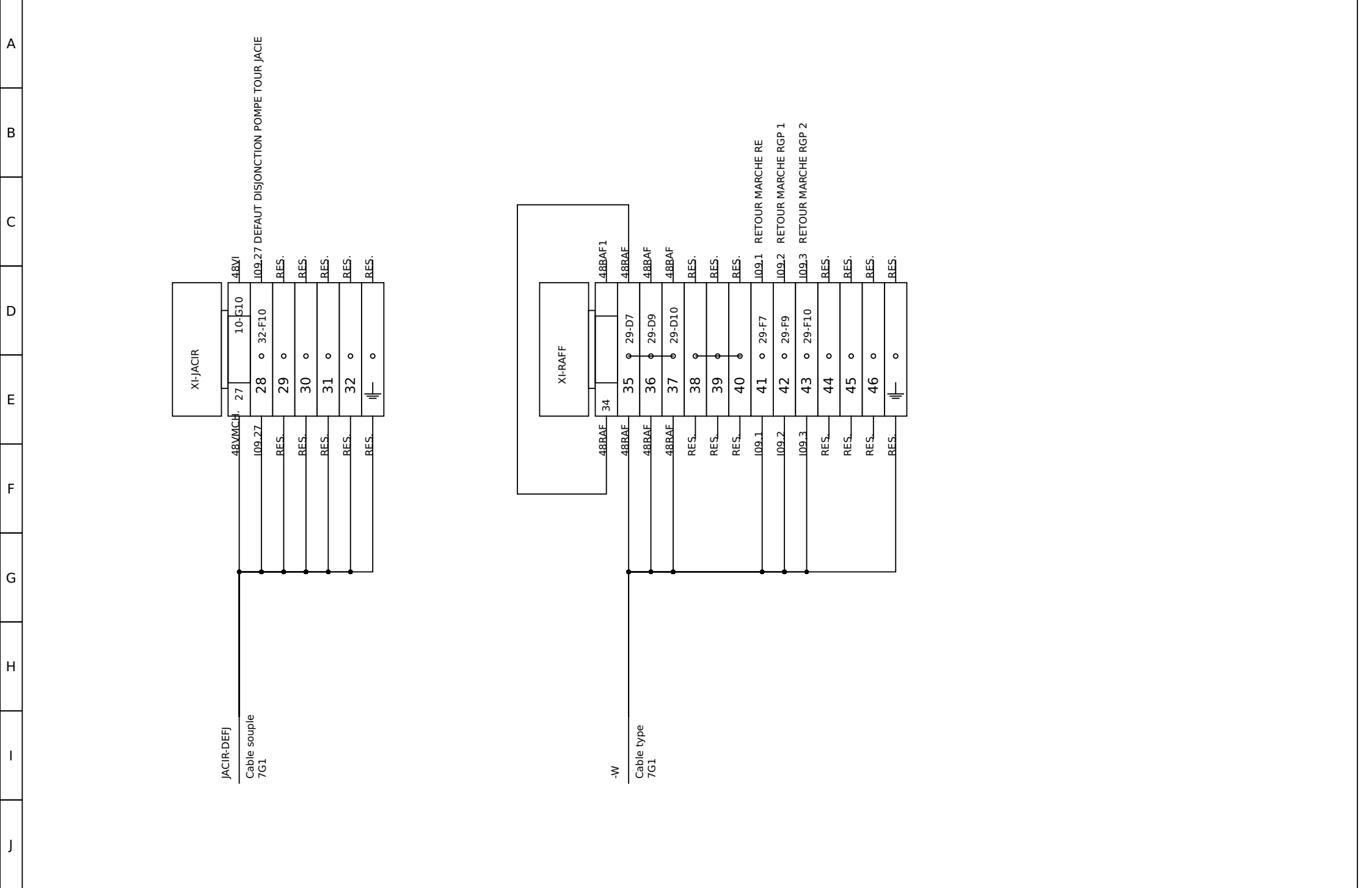



1 2 3 4 5 6 7 8 9 10 11 12 13 14 15 16 17 18 19 20

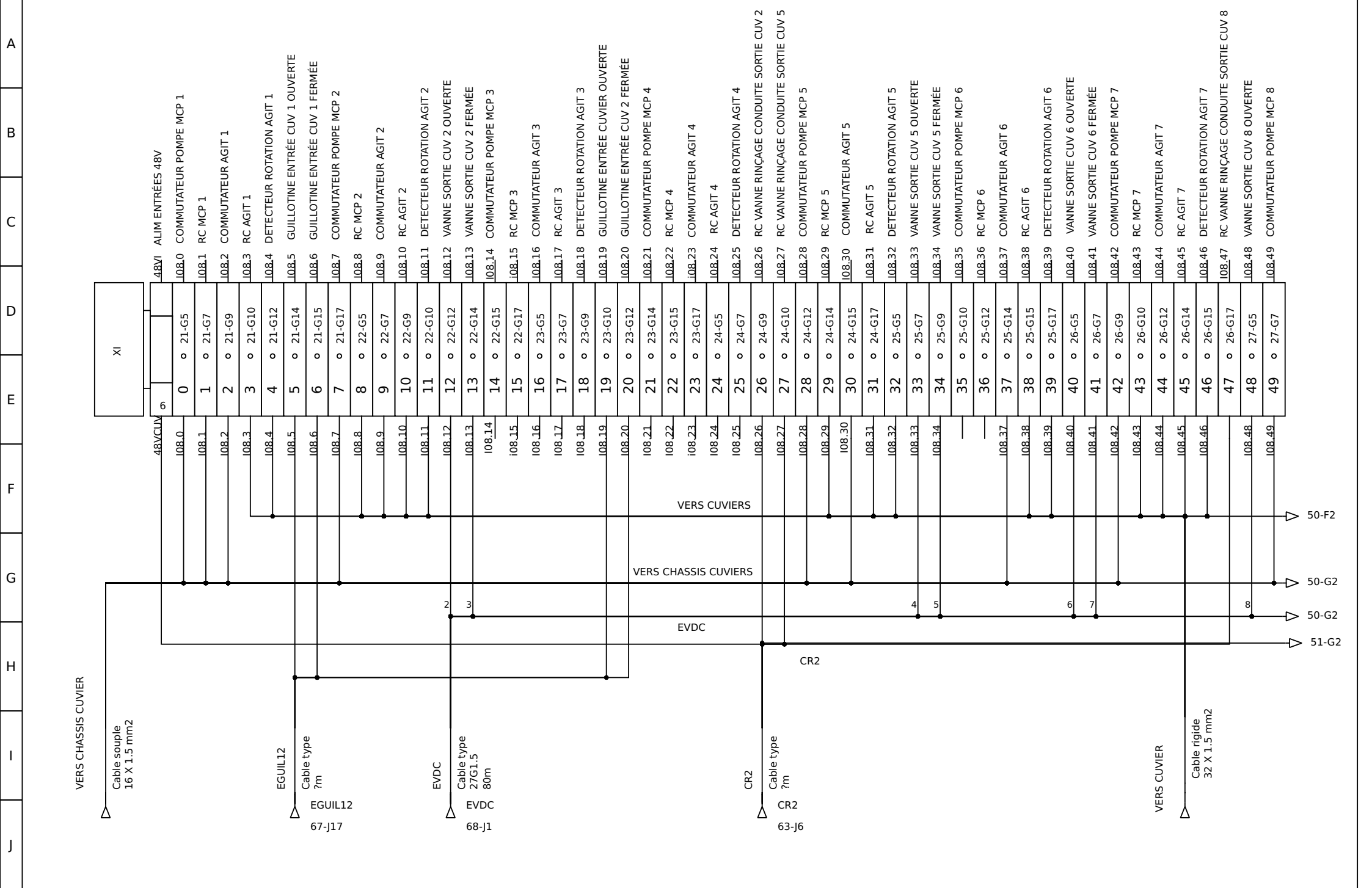

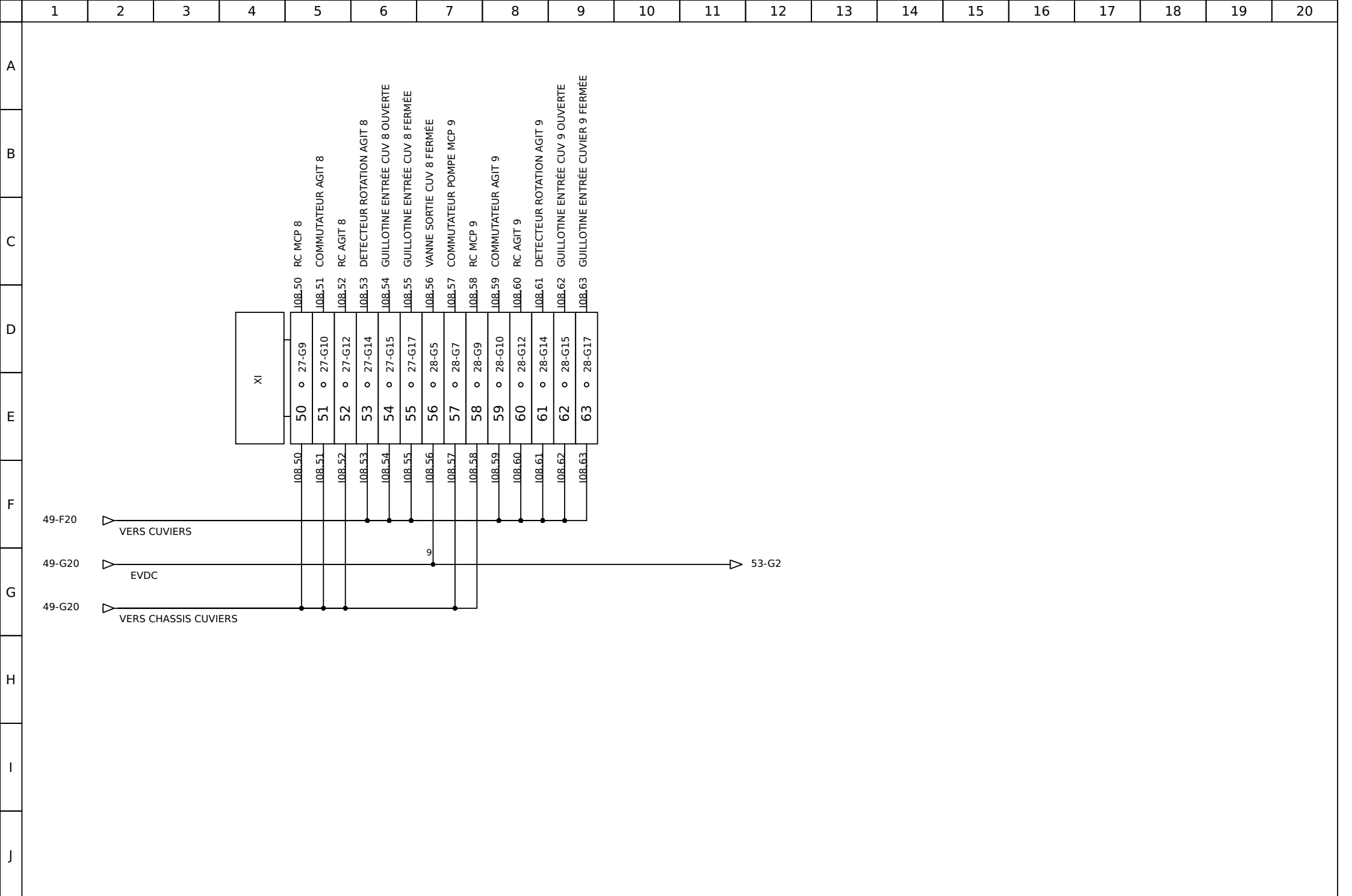



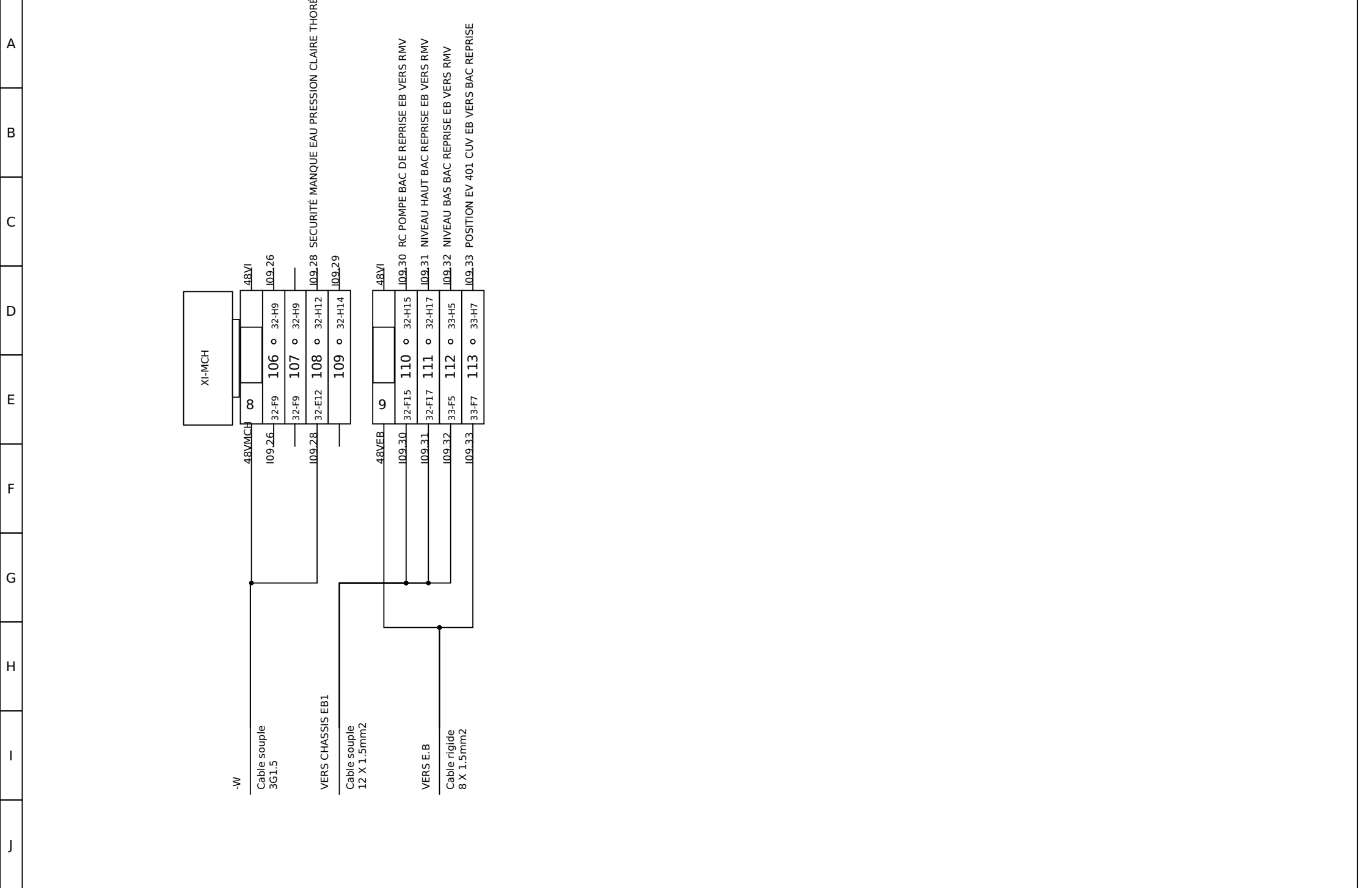

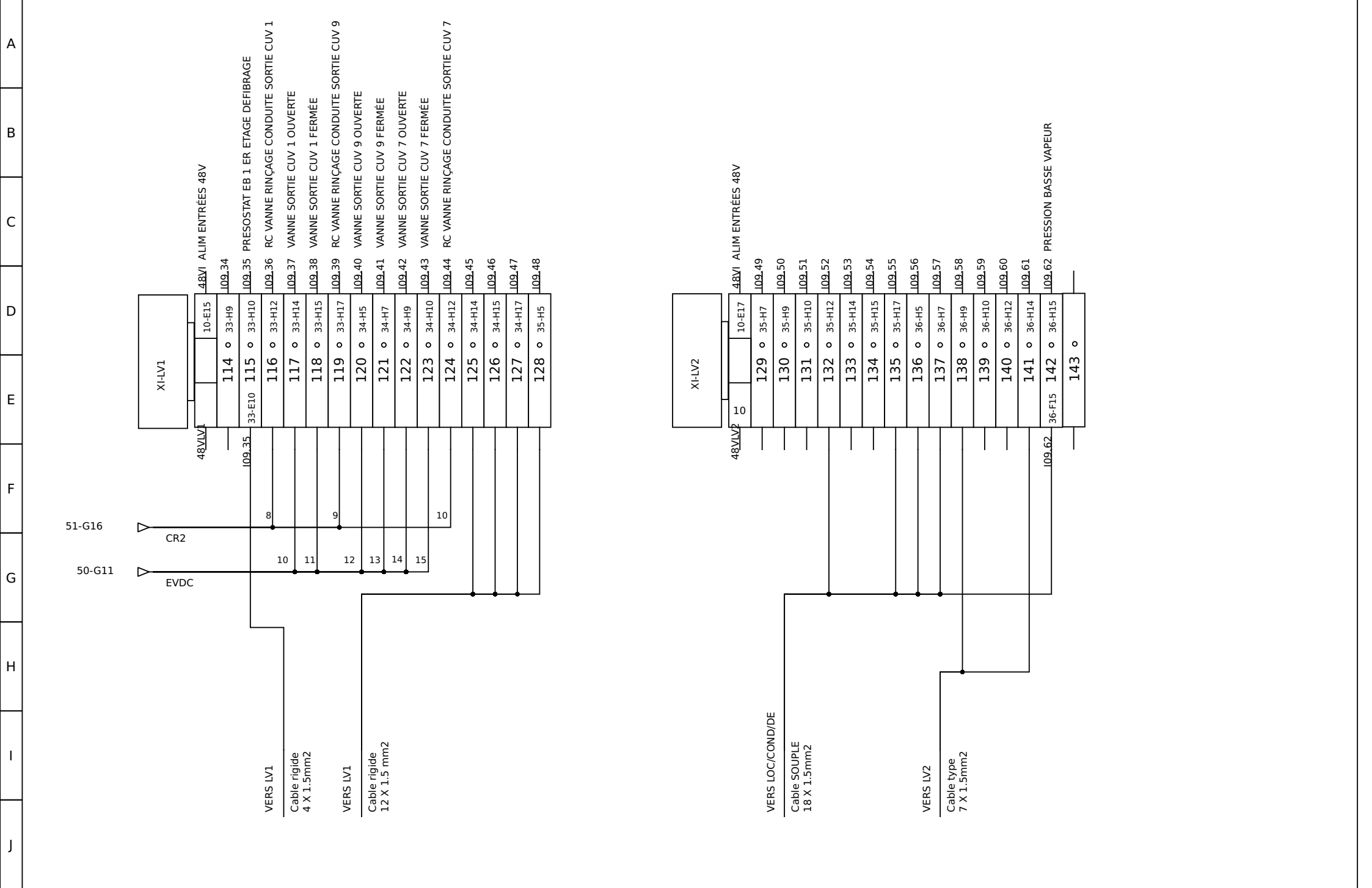

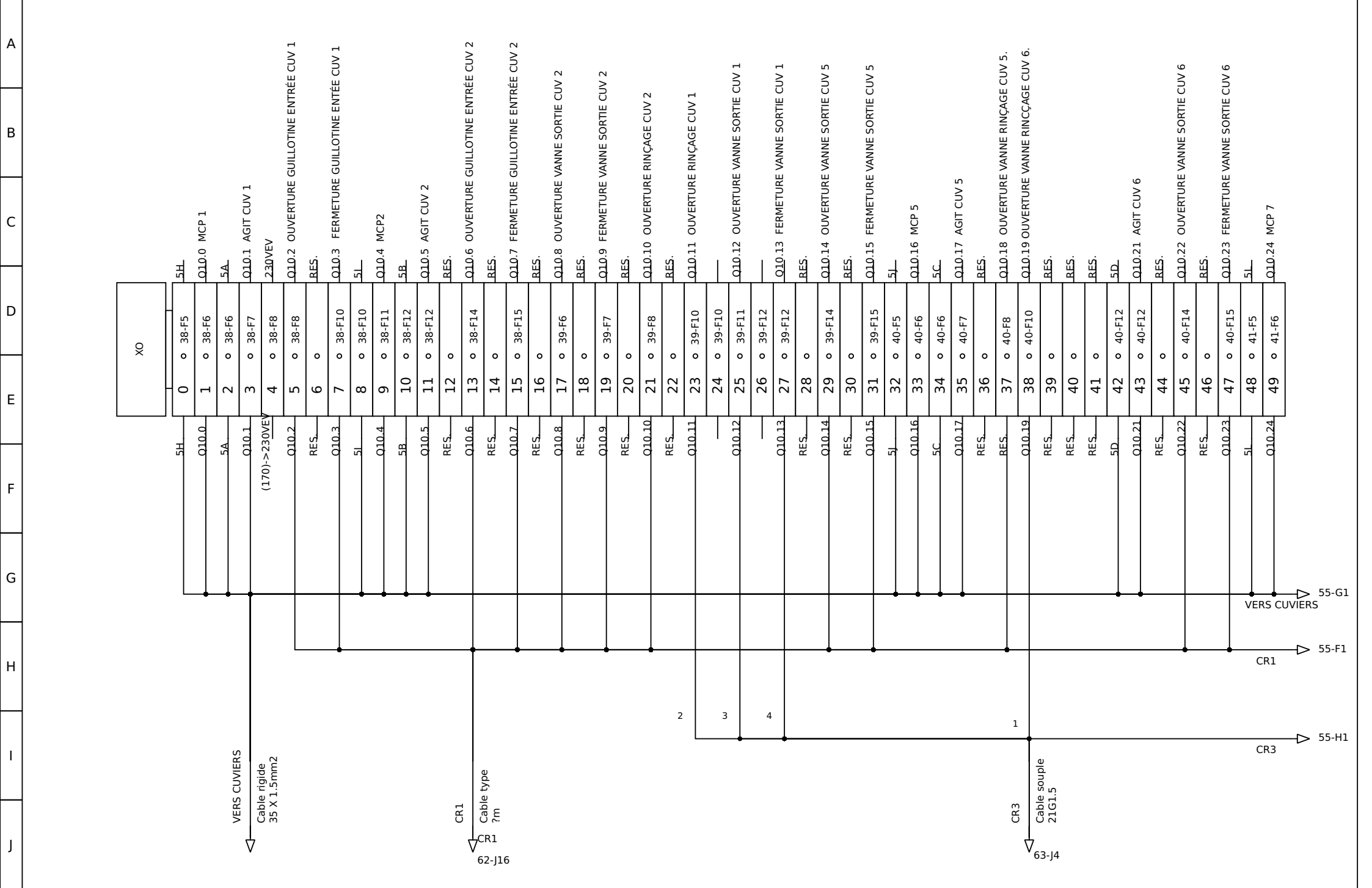

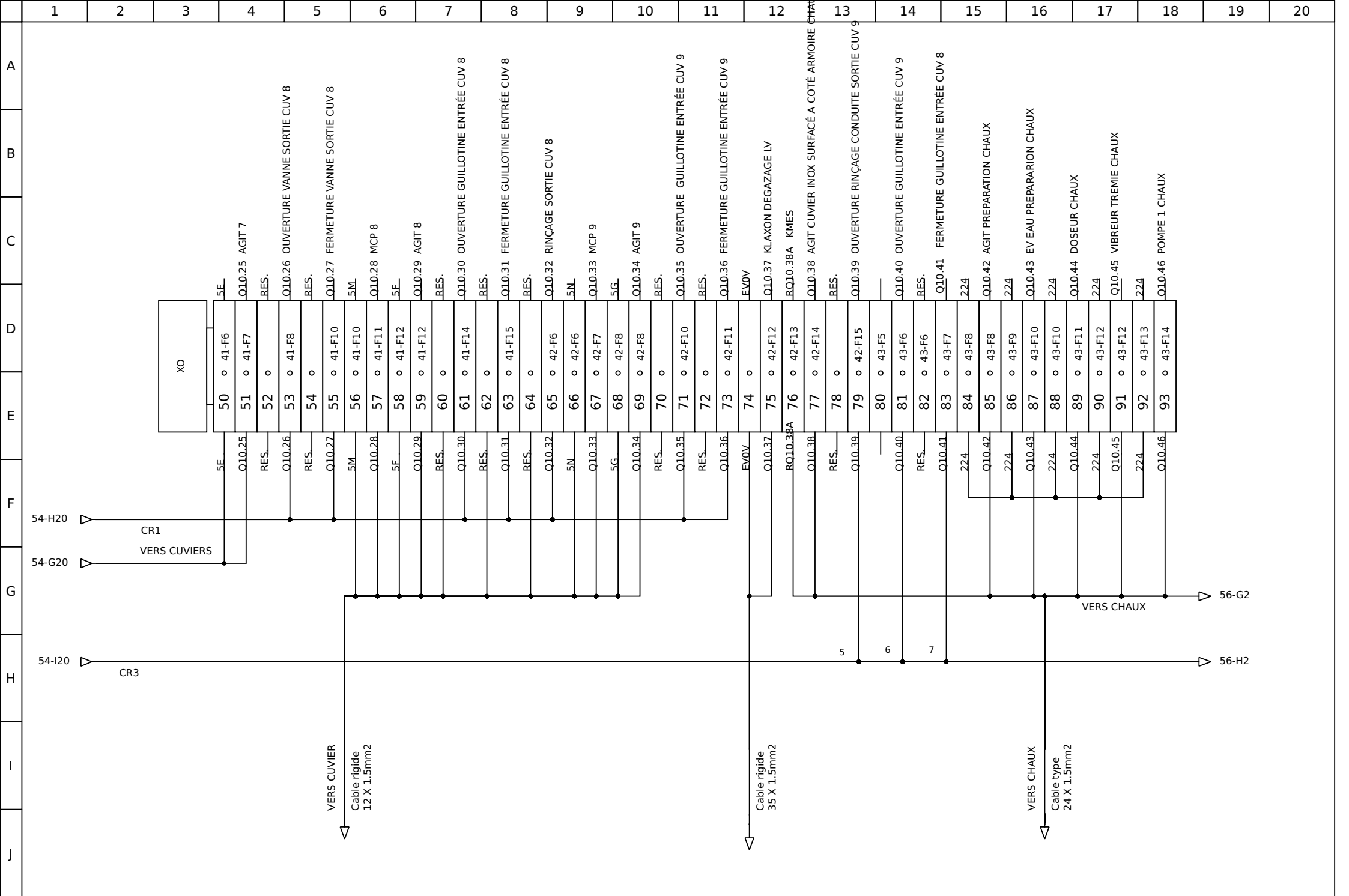

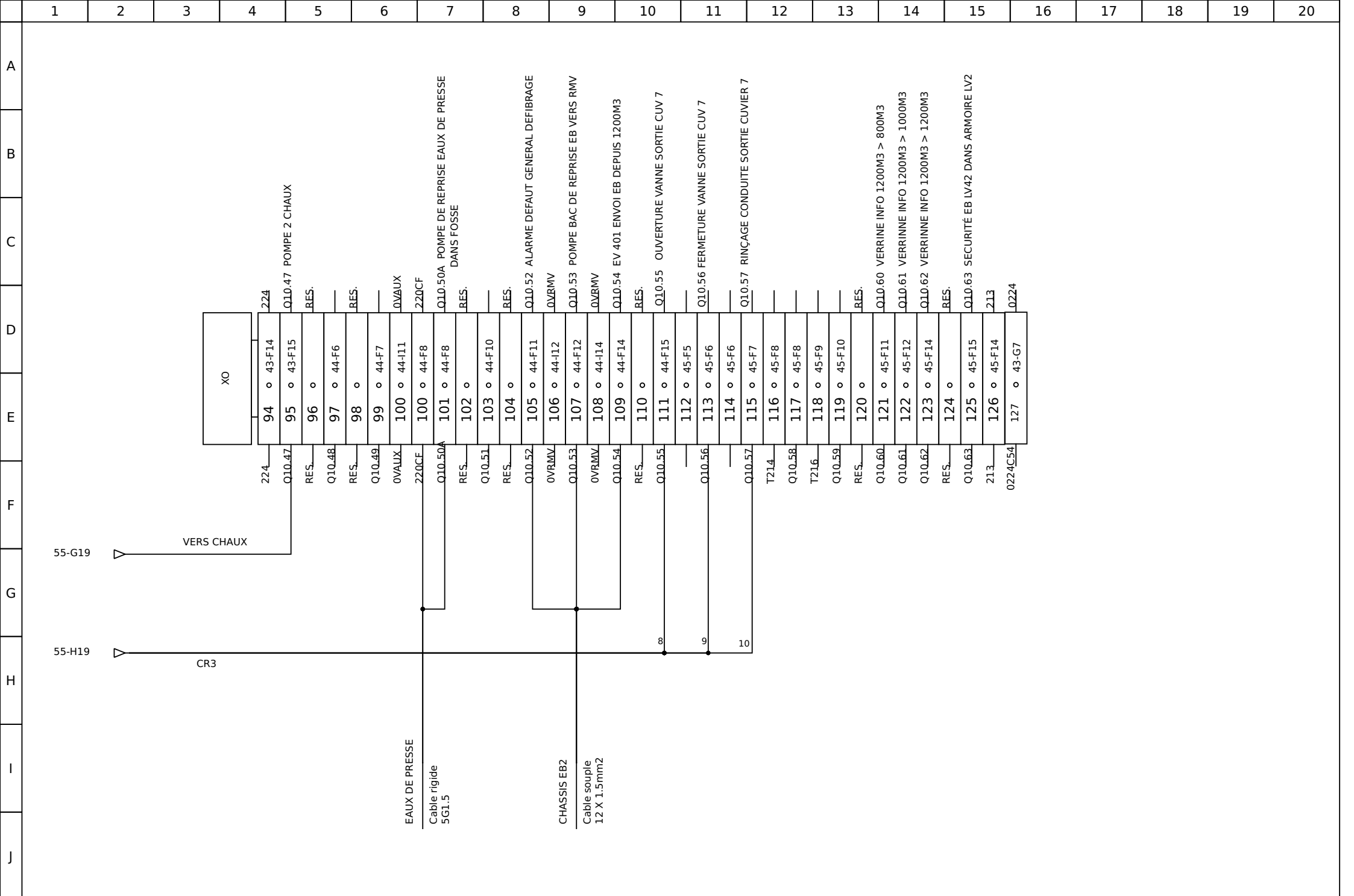



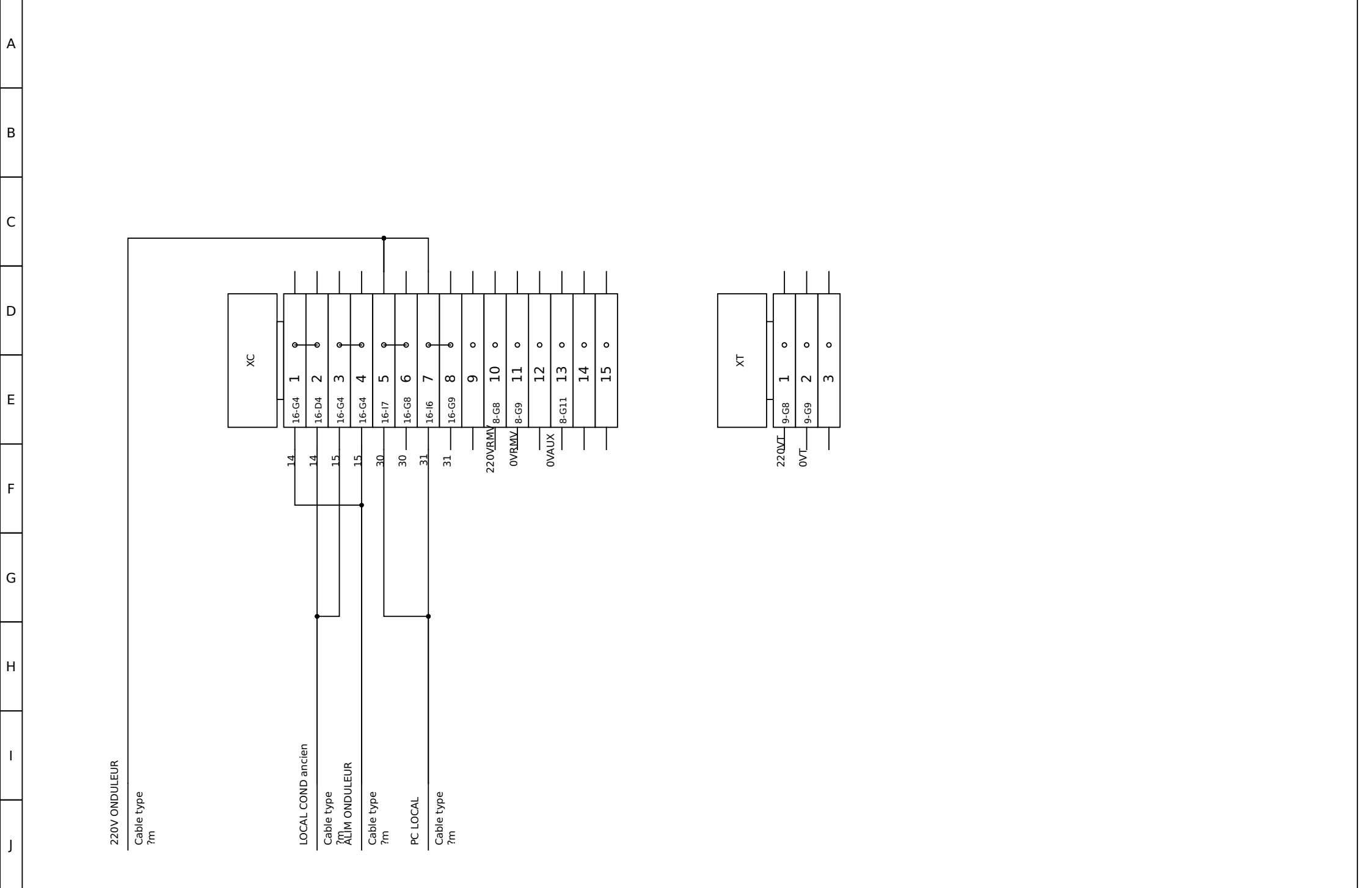

	1	2	3	4	5	6	7	8	9	10	11	12	13	14	15	16	17	18	19	20
A																				
B																				
C																				
D																				
E																				
F																				
G																				
H																				
I																				
J																				

Auteur : L.T

Date : 25/10/2017

RESERVE

Fichier : GESTION DEFIBRAGE

Folio : 58/72

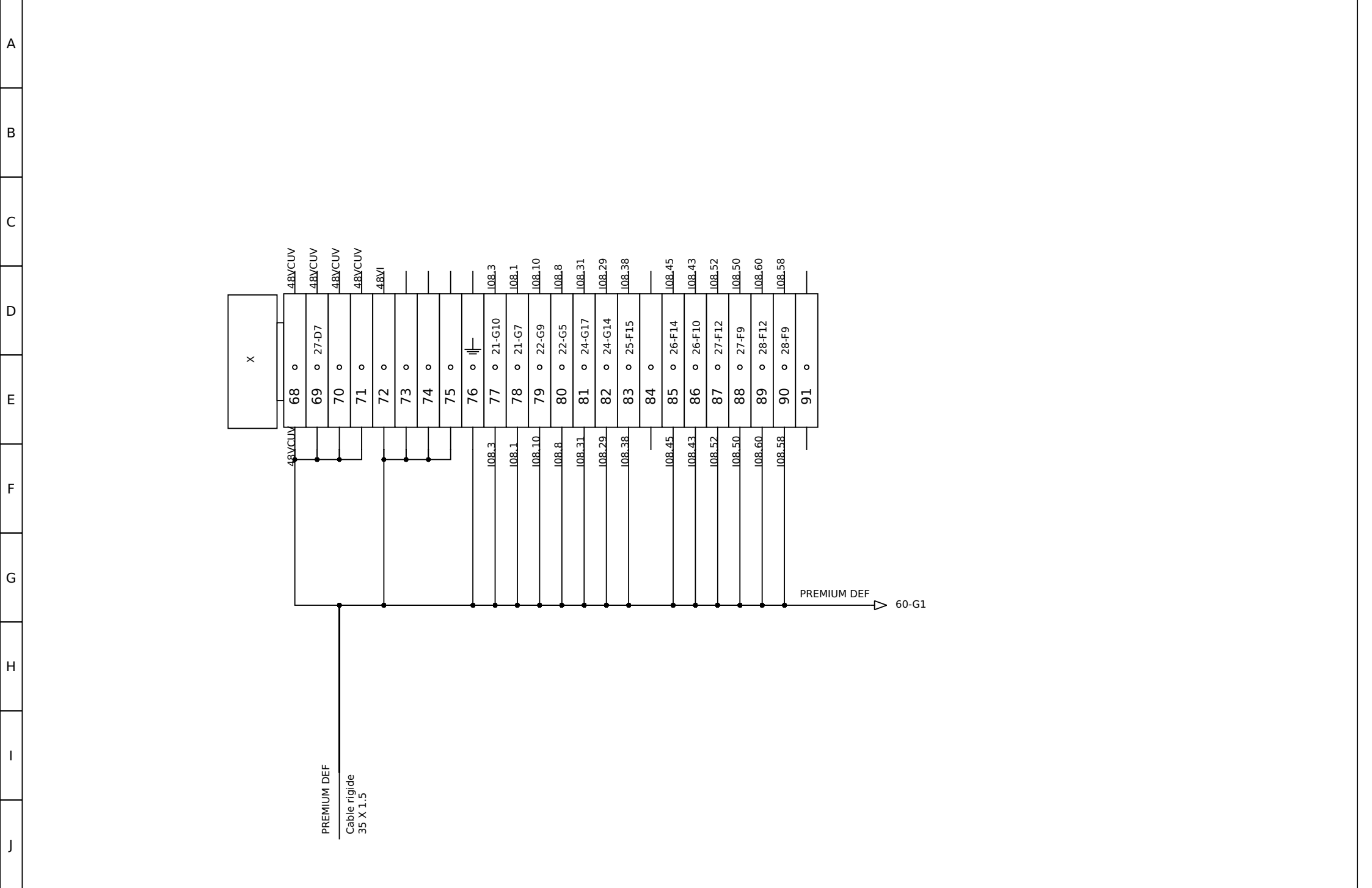

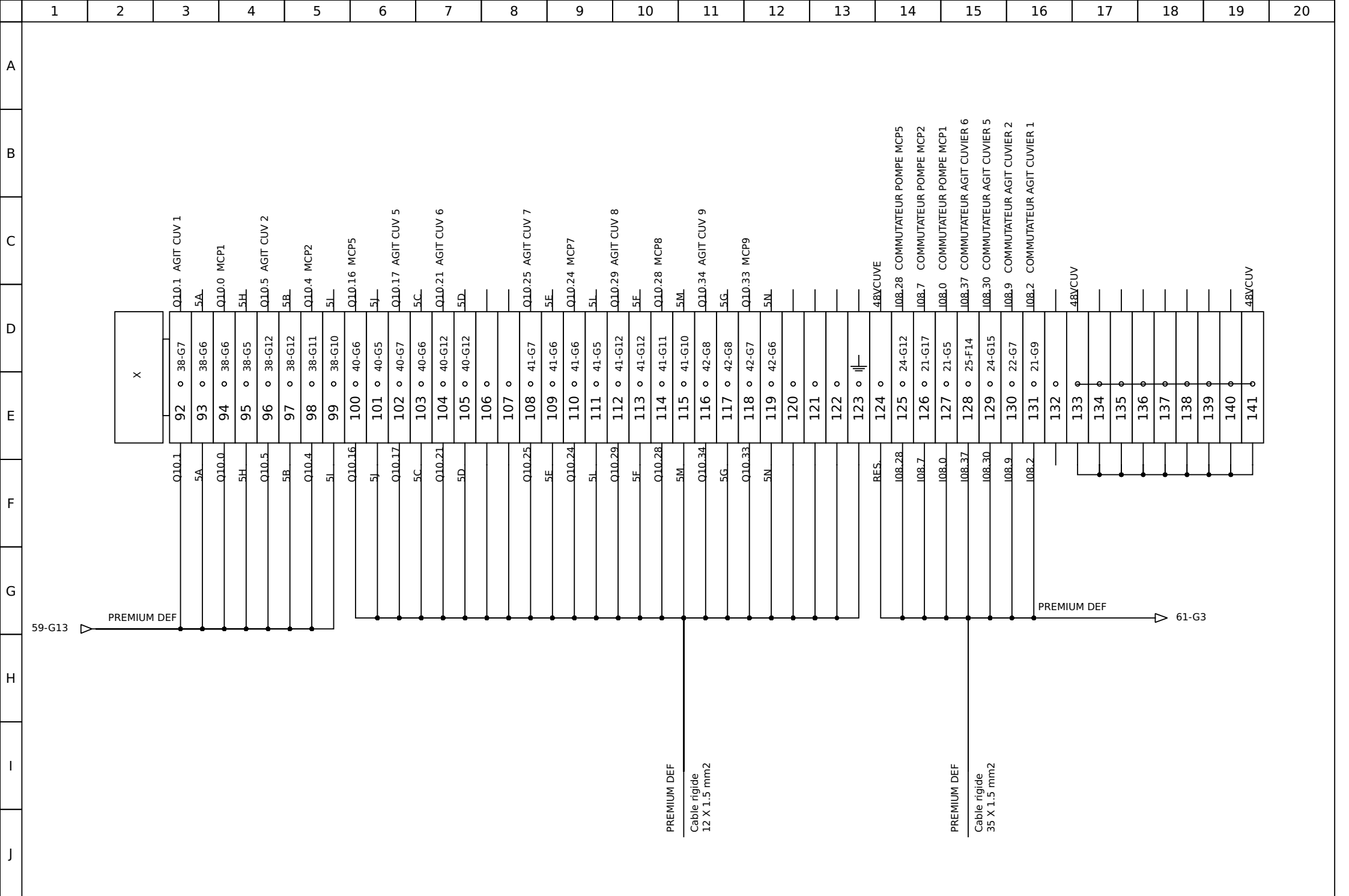

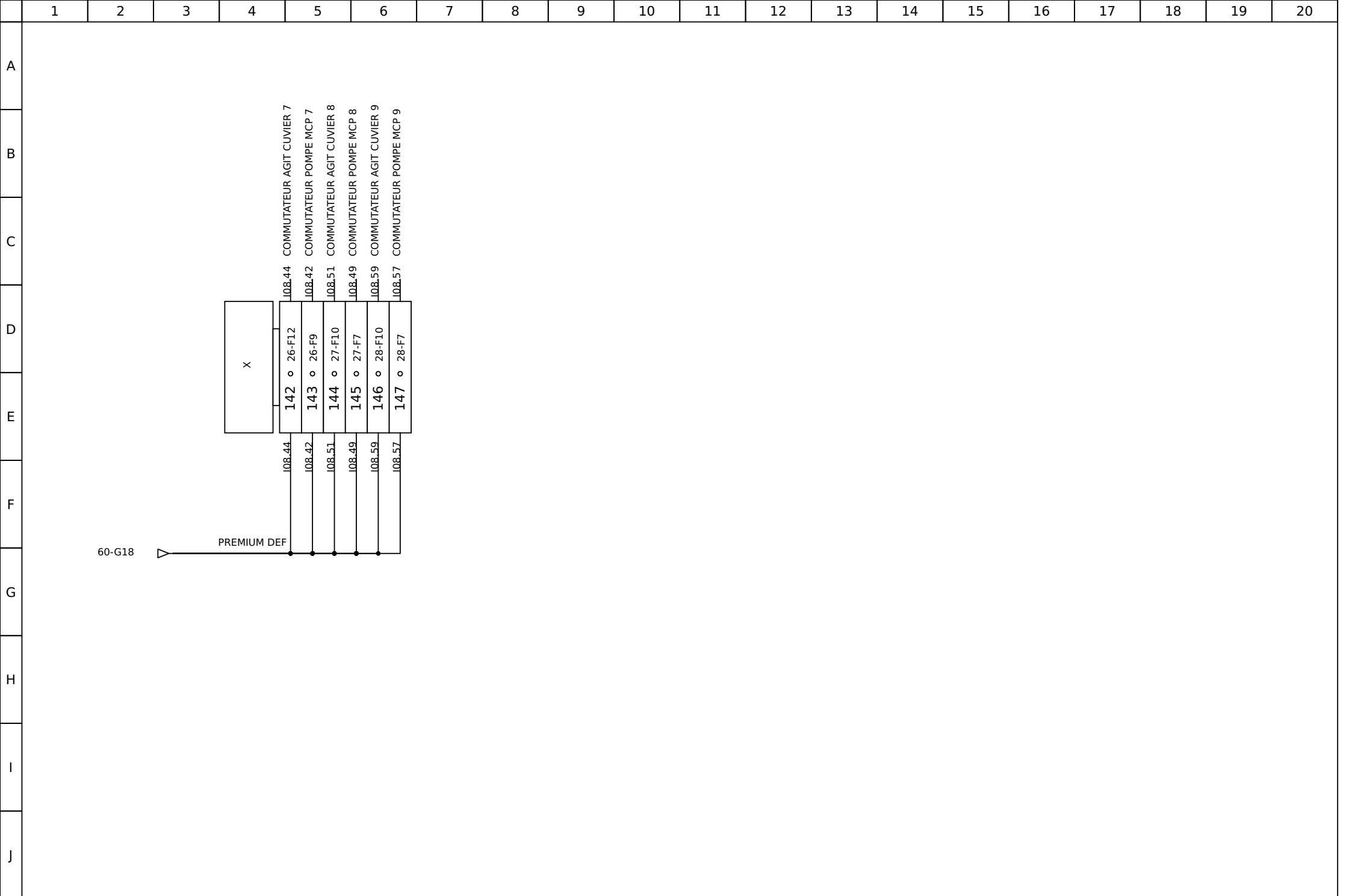

1 2 3 4 5 6 7 8 9 10 11 12 13 14 15 16 17 18 19 20

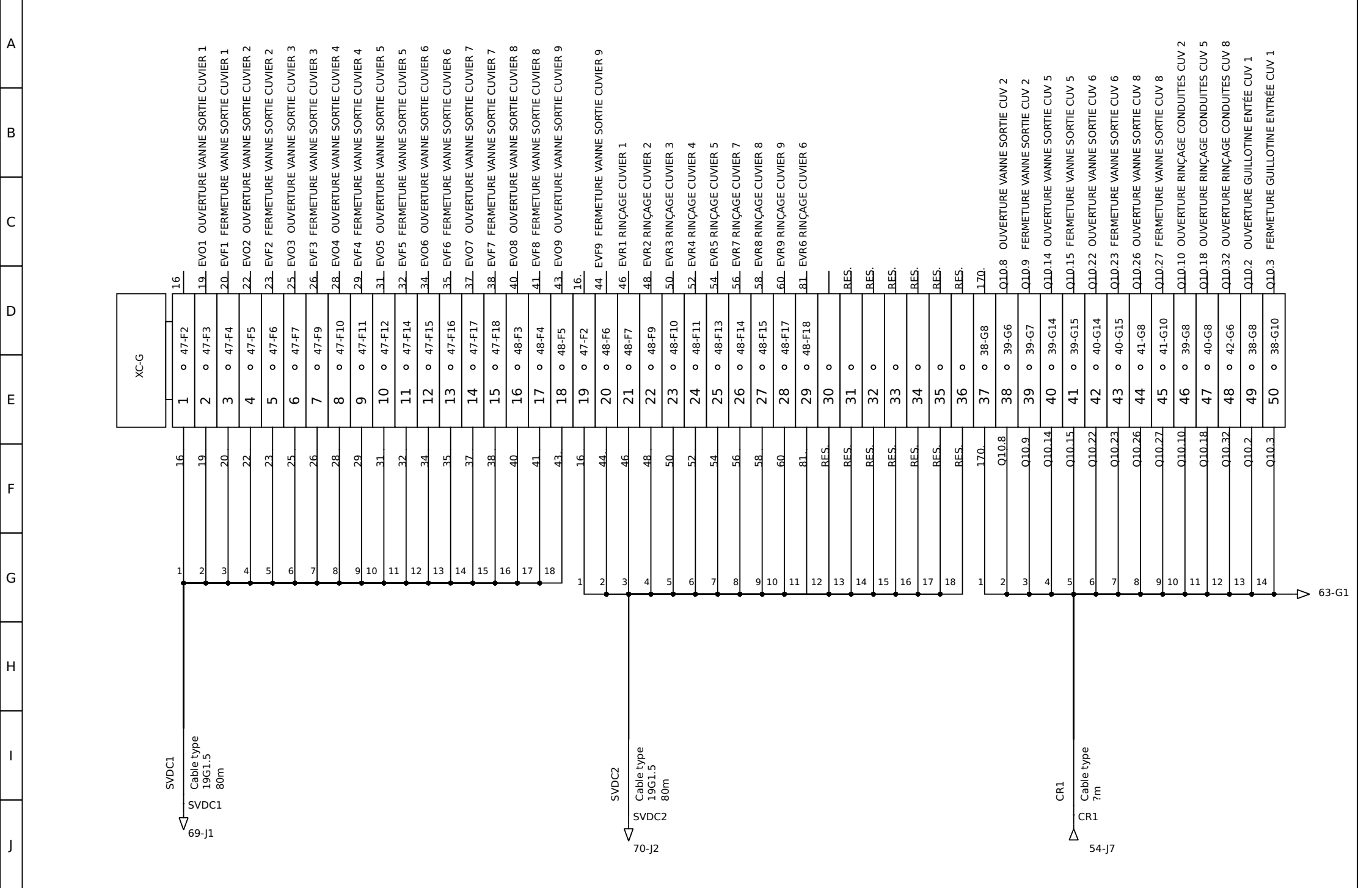



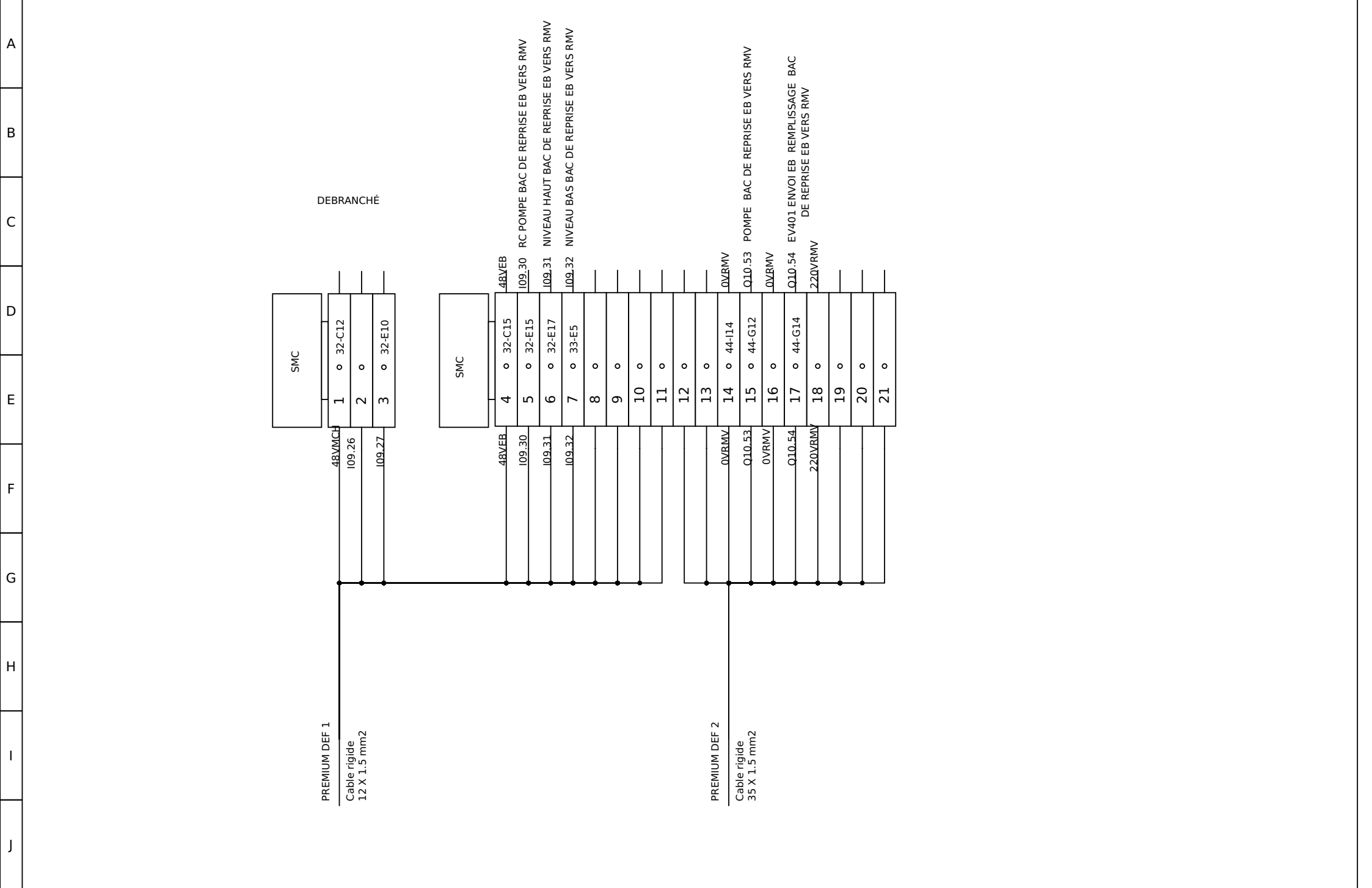



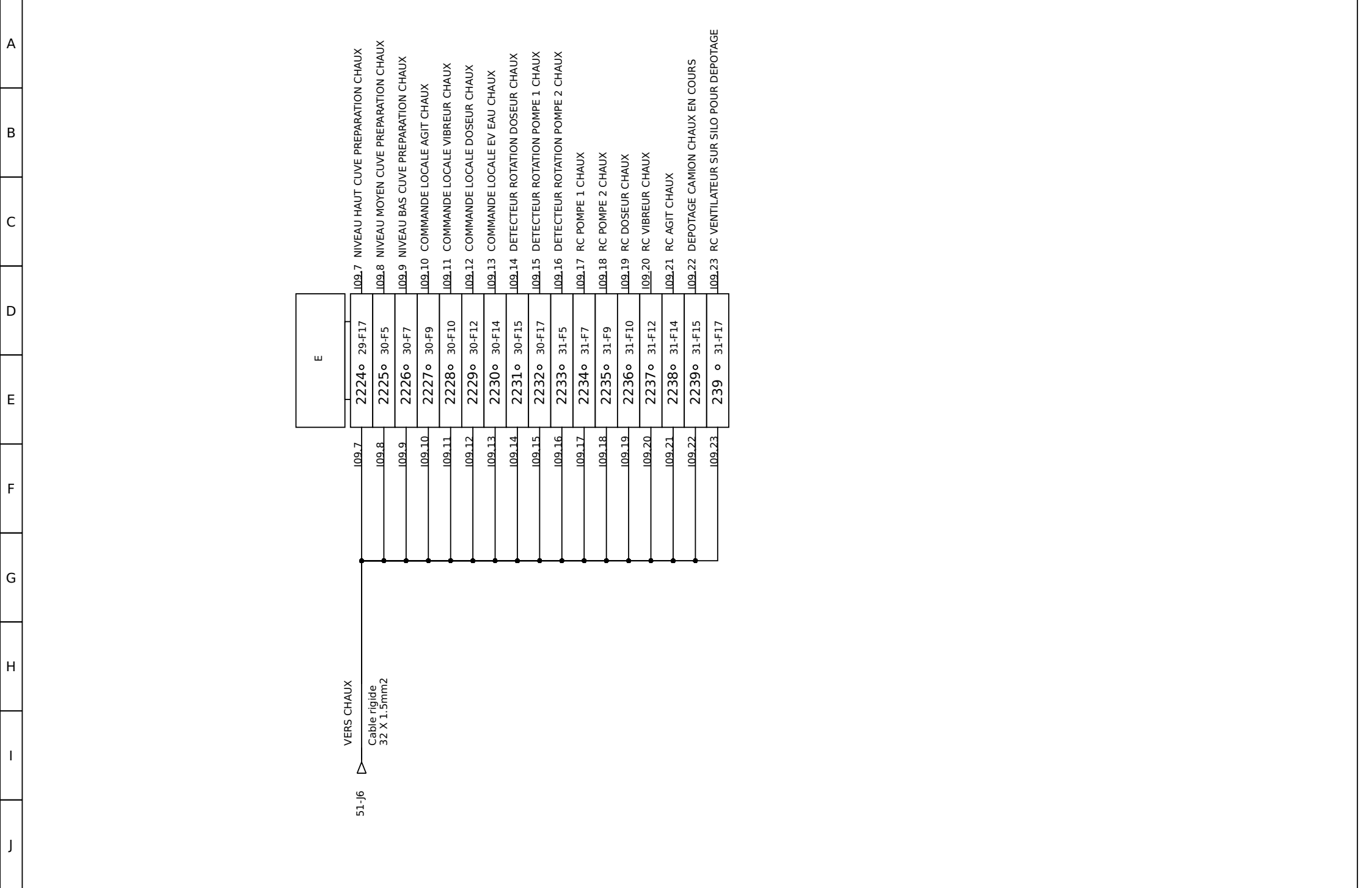

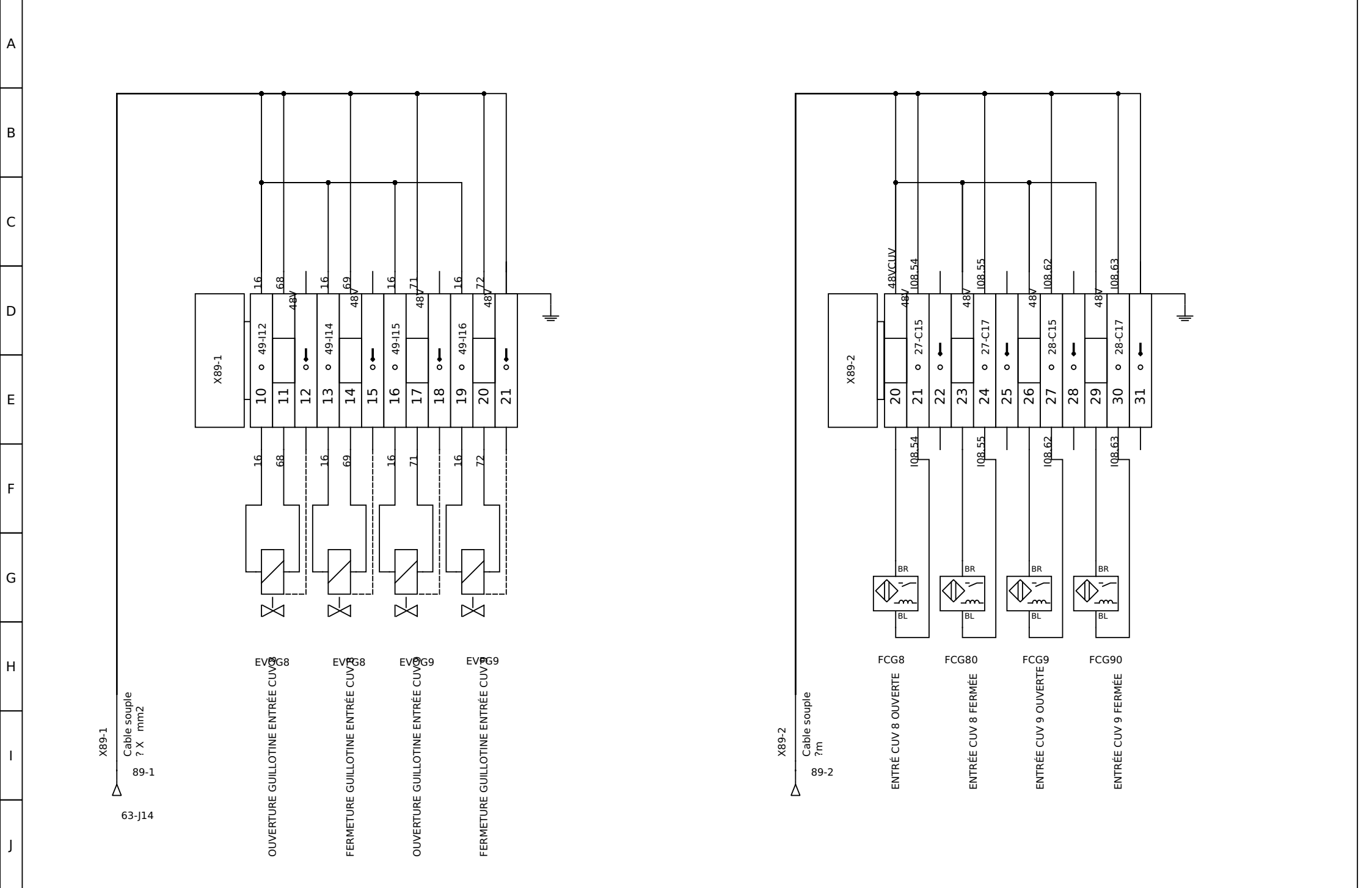

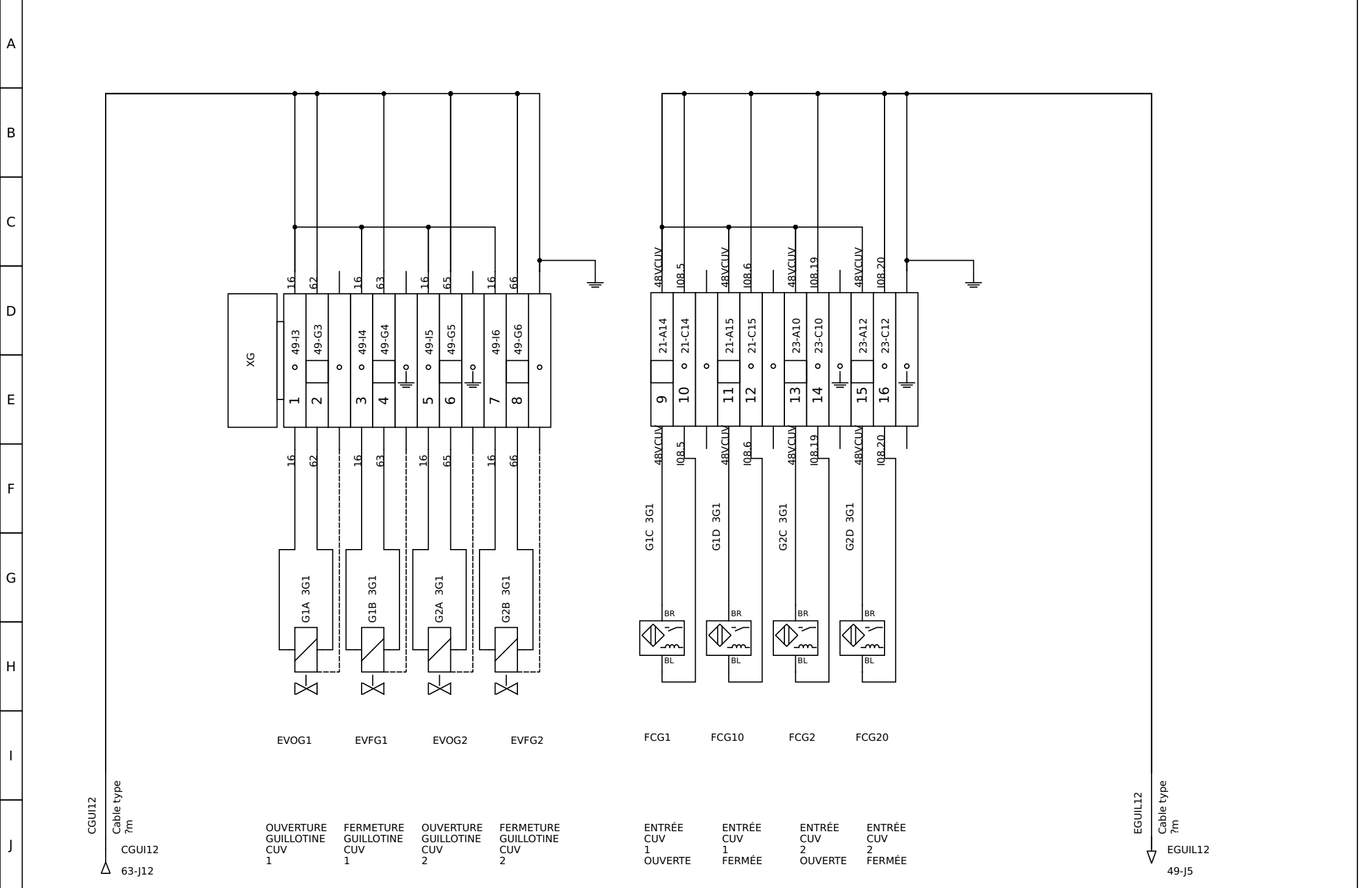

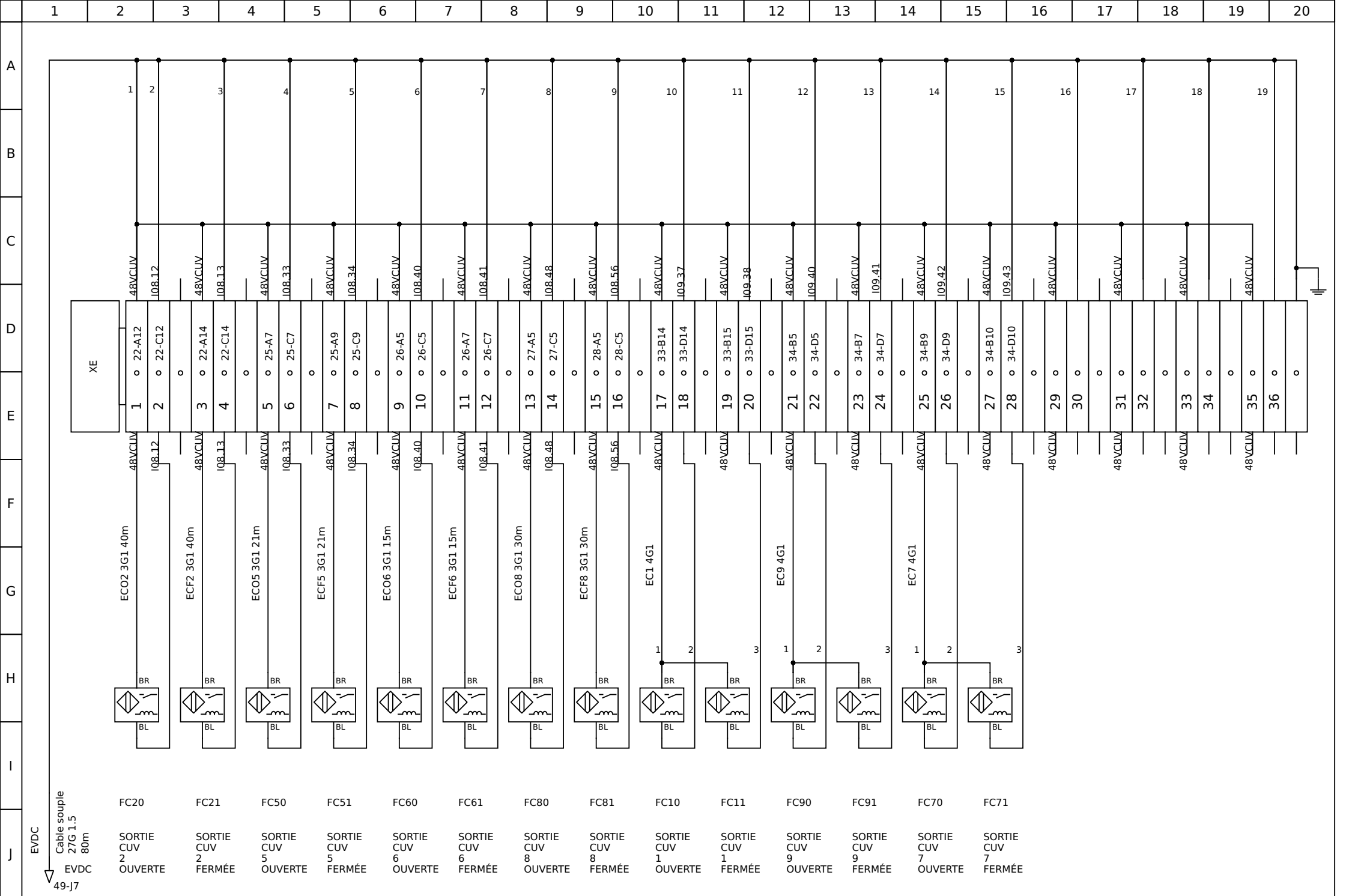

1 2 3 4 5 6 7 8 9 10 11 12 13 14 15 16 17 18 19 20

A

B

C

D

E

F

G

H

I

J

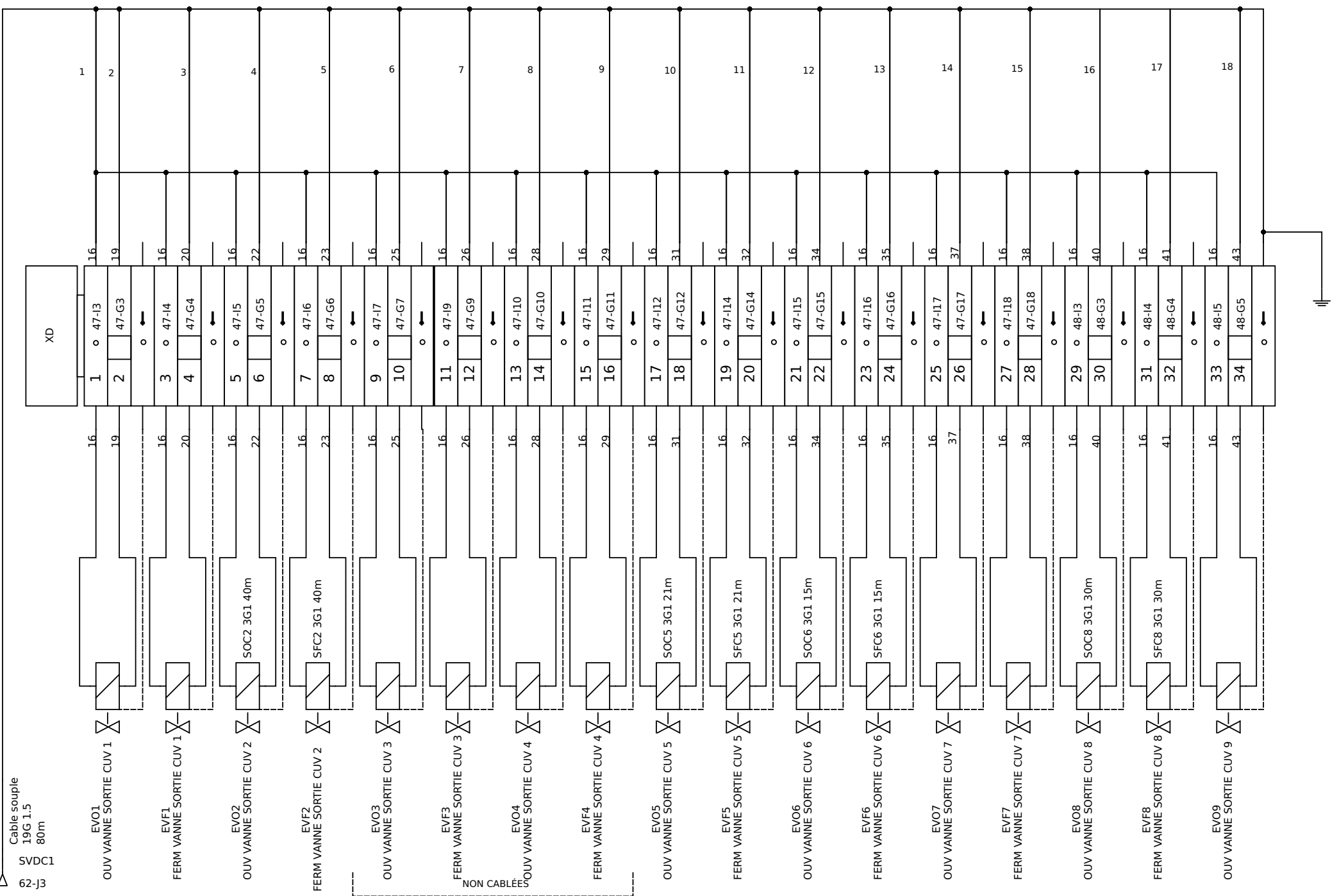



	1	2	3	4	5	6	7	8	9	10	11	12	13	14	15	16	17	18	19	20
A																				
B																				
C																				
D																				
E																				
F																				
G																				
H																				
I																				
J																				
Auteur : L.T																	Fichier : GESTION DEFIBRAGE			
Date : 25/10/2017																	Folio : 71/72			

# FOLIO RESERVE

	1	2	3	4	5	6	7	8	9	10	11	12	13	14	15	16	17	18	19	20
A																				
B																				
C																				
D																				
E																				
F																				
G																				
H																				
I																				
J																				
Auteur : L.T																	Fichier : GESTION DEFIBRAGE			
Date : 25/10/2017																	Folio : 72/72			